



GEFORCE RTX™ 5070

Quick Start Guide

01 System Specifications

Thank you for choosing the NVIDIA® GeForce RTX™ 5070 graphics card. Before you begin, please review the following System Specifications to ensure your PC has the appropriate hardware and software for your new graphics card.

System Specifications

> **Motherboard:**

PCI Express® graphics slot required.

> **Clearance:**

Must have space for 244mm (L) x 112mm (W) x 41mm (H) card.

One additional slot clearance in front of the fans is recommended for better airflow.

➤ **System Power Supply:**

- 650 W power rating minimum.
- Supported power connector configurations:
 - At least two PCIe 8-pin cables
(with RTX 5070 PCIe Gen 5 Power Connector Adapter).
 - One 360 W or greater PCIe Gen 5 Cable (16-pin).

➤ **Operating System:**

- Microsoft® Windows® 11 64-bit recommended.
- Linux, 64-bit.

➤ **Driver Installation:** 2 GB of available disk space required for driver installation.

02 Equipment

The following equipment is included in the NVIDIA GeForce RTX 5070 graphics card box.

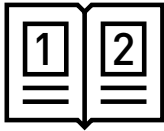

**Quick Start
Guide**

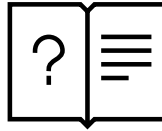

**Support
Guide**

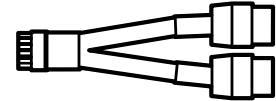

**NVIDIA PCIe
Gen5 16-pin power
connector adapter**



Attention: Use only the included NVIDIA power connector adapter for your GeForce RTX 50 Series Founders Edition graphics card.

PCIe Gen5 16-pin Power Connector

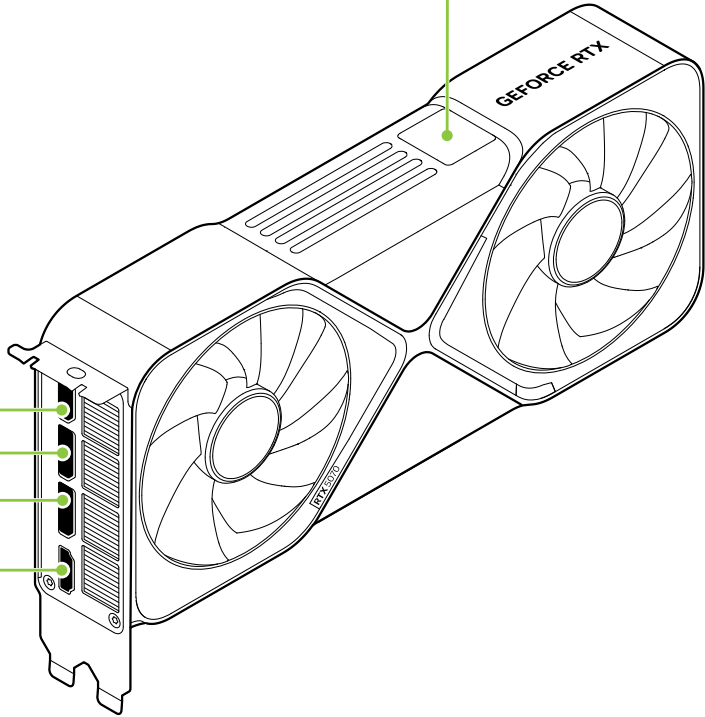
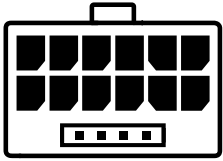

DisplayPort Connectors (x3)

HDMI Connector

GeForce RTX 5070 Graphics Card

03 Hardware Installation

- 1 Turn off your computer, disconnect the power cord and remove any existing graphics card(s).



Note: Use the GeForce RTX 5070 graphics card with UL listed ITE Personal Computer (PC)/Server.



Attention: It is very important that you wait until the graphics card has cooled before taking the card out of the system.

2 Remove two slot covers if there was no existing graphics card.

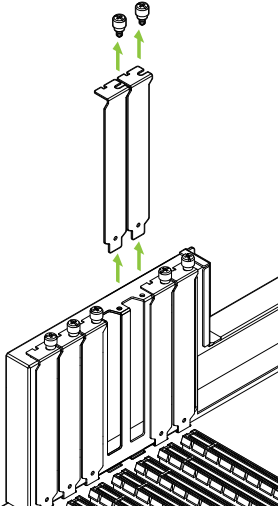

Remove two adjacent slot covers that correspond to the PCI Express slot you are installing the graphics card in.

- 3 Connect the 16-pin plug of NVIDIA power connector adapter to the power receptacle on the top of the GeForce RTX 5070 graphics card.

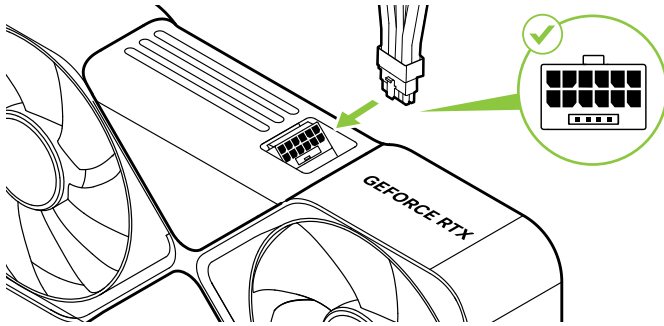

Connect at least two independent dedicated cables with 8-pin PCI Express plugs from the system power supply to the NVIDIA power connector adapter.



Attention: Use only the included NVIDIA power connector adapter for your GeForce RTX 50 Series Founders Edition graphics card.

To help ensure the connector is secure we recommend plugging the power dangle into the graphics card first to ensure it's firmly and evenly plugged in, before plugging the graphics card into the motherboard.



Attention: Ensure the power plug is fully inserted and seated flush against the power receptacle.

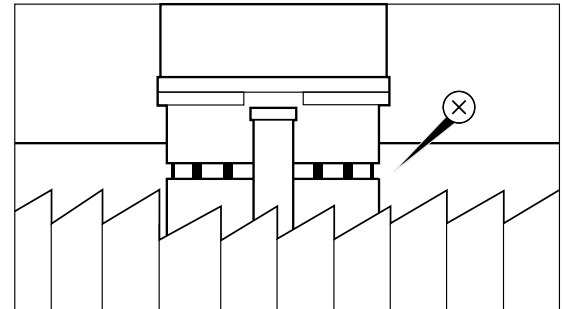
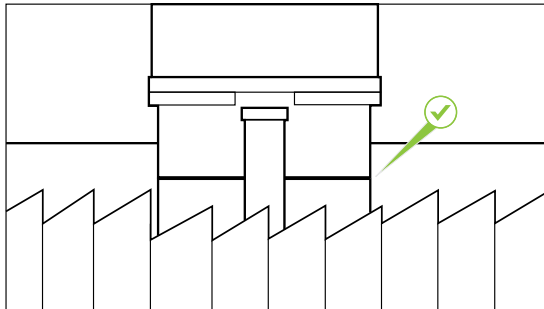

- 4 Install the GeForce RTX 5070 graphics card into the primary PCI Express x16 slot on your motherboard.

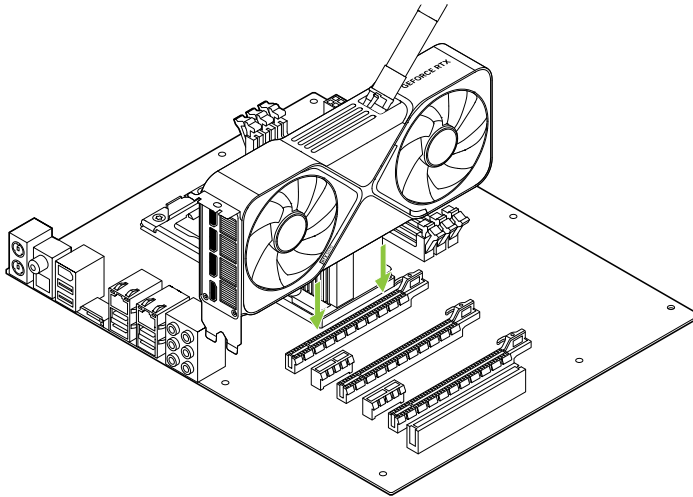

Install your GeForce RTX 5070 into the Primary PCI Express x16 slot (the Primary slot is the one closest to the CPU).



Attention: This GPU card should not be installed with the I/O brackets facing downwards.

- 5 Reinstall the covers on your computer and reconnect any cables previously removed.

04 Connecting To The Display

- 1 Connect the display(s) to the graphics card.
- 2 Reconnect your power cord to the PC.

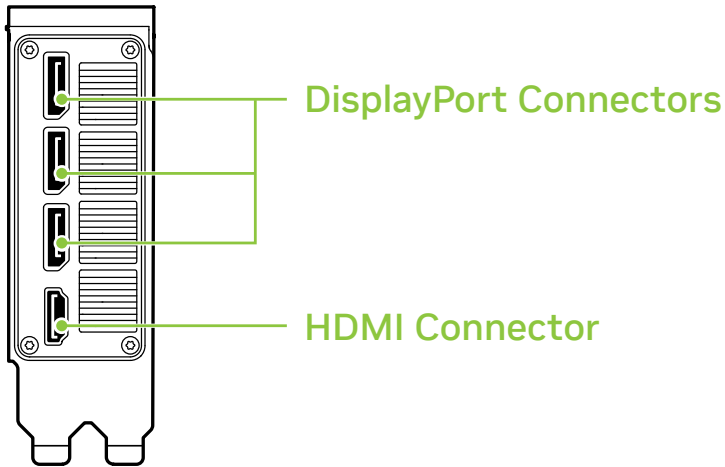

05 Software Installation And Configuration

With the hardware installed, the final step is to install the NVIDIA App software to update your drivers and optimize your games.

- 1 Download and install NVIDIA App software.
 - Go to <https://www.nvidia.com/en-us/software/nvidia-app/> and click **Download Now**.
 - Accept the NVIDIA software license agreement by selecting **Agree and Continue**. NVIDIA App software begins to install.
 - Select **Close** to finish the installation.

2 Congratulations! Your GeForce graphics card is now ready to use!



Note: If you have any questions about your NVIDIA product you can Chat live with NVIDIA Customer Care at www.nvidia.com/support or call 1-800-797-6530 (US) or 0800 404 7747 (UK).

01 Spécifications Système

Merci d'avoir choisi la carte graphique NVIDIA® GeForce RTX™ 5070. Avant de commencer, veuillez vérifier les spécifications système suivantes pour vous assurer que votre PC dispose du matériel et des logiciels appropriés pour votre nouvelle carte graphique.

Spécifications système

> Carte mère:

Slot graphique PCI Express® requis.

> Clearance:

Vous devez disposer d'un espace suffisant pour accueillir une carte de 244 mm (L) et 112 mm (l) sur 41 mm (H).

Il est recommandé de disposer d'un logement additionnel devant les ventilateurs pour une meilleure circulation de l'air.

➤ **System Power Supply:**

- Puissance minimale de 650 W.
- Configurations d'alimentation prises en charge :
 - Au moins deux câbles PCIe à 8 broches (avec adaptateur d'alimentation RTX 5070 PCIe Gen 5).
 - Un câble RTX PCIe Gen 5 de 360 W ou plus (16 broches).

➤ **Système d'exploitation:**

- Microsoft® Windows® 11 64 bits recommandé.
- Linux, 64-bit.

➤ **Installation des pilotes:** 2 Go d'espace disque disponible sont requis pour l'installation des pilotes.

02 Équipement

L'équipement suivant est inclus avec votre carte graphique NVIDIA GeForce RTX 5070.

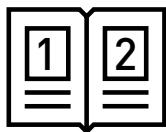

Guide de
démarrage rapide

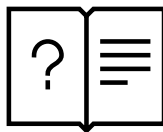

Guide
d'assistance

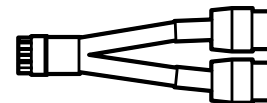

Adaptateur
d'alimentation PCIe
Gen5 à 16 broches de
NVIDIA



Attention: Utilisez exclusivement l'adaptateur d'alimentation de NVIDIA fourni avec votre carte graphique GeForce RTX série 50 Founders Edition.

Connecteur d'alimentation
PCIe Gen 5 à 16 broches.

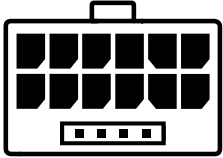

Connecteurs
DisplayPort (x3)

HDMI Connector

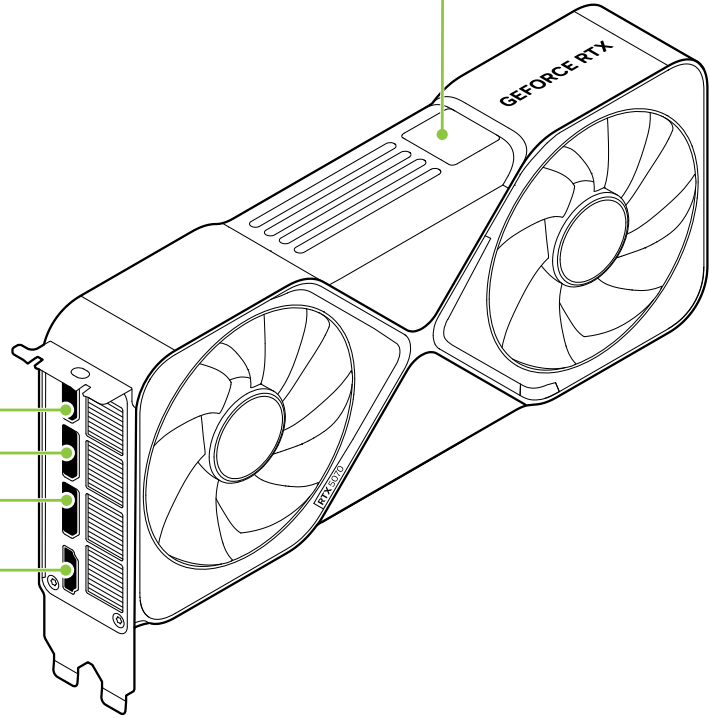

Carte graphique GeForce RTX 5070

03 Installation Du Matériel

- 1 Veuillez éteindre votre ordinateur avant de déconnecter le câble d'alimentation et de retirer toute carte graphique existante installée sur la carte mère.



Remarque: Utilisez la carte graphique GeForce RTX 5070 avec un ordinateur personnel (PC)/serveur ITE homologué UL.



Attention: Ne débranchez jamais une carte graphique à chaud. Veuillez attendre son refroidissement complet avant de la retirer du système.

- 2 Retirez deux caches pour logement si aucune carte graphique ne se trouve dans votre boîtier.

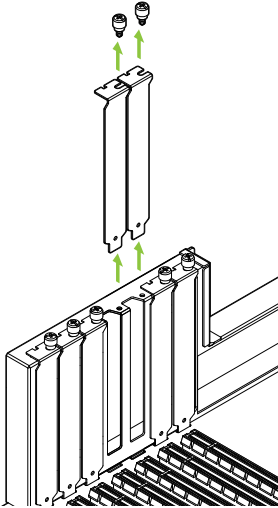

Retirez les deux caches adjacents pour logement d'extension qui correspondent au logement PCI Express dans auquel vous souhaitez installer votre carte graphique.

- 3 Connectez la fiche à 16 broches de l'adaptateur d'alimentation de NVIDIA au connecteur d'alimentation qui se trouve sur le haut de la carte graphique GeForce RTX 5070.

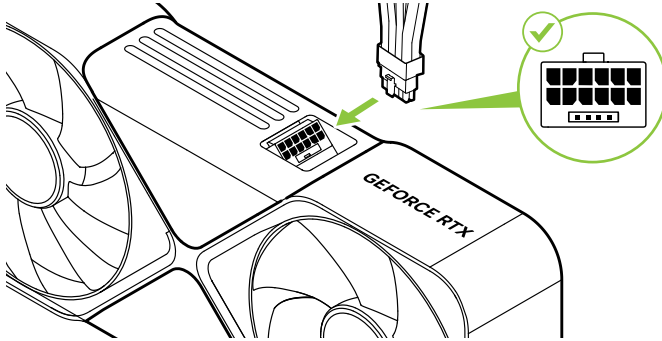

Connectez au moins deux câbles indépendants et dédiés (dotés de fiches PCI Express à 8 broches) de l'alimentation du système à votre adaptateur d'alimentation de NVIDIA.



Attention: Utilisez exclusivement l'adaptateur d'alimentation de NVIDIA fourni avec votre carte graphique GeForce RTX série 50 Founders Edition.

Pour vous assurer que le connecteur est sécurisé, nous vous recommandons de brancher d'abord le dongle d'alimentation sur la carte graphique pour vous assurer qu'il est fermement et uniformément branché, avant de brancher la carte graphique sur la carte mère.



Attention: Assurez-vous que la fiche d'alimentation est complètement insérée et bien calée contre la prise de courant.

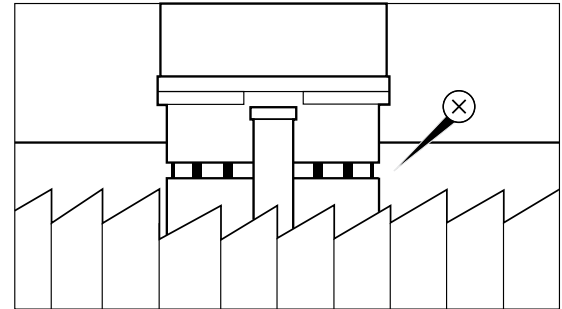
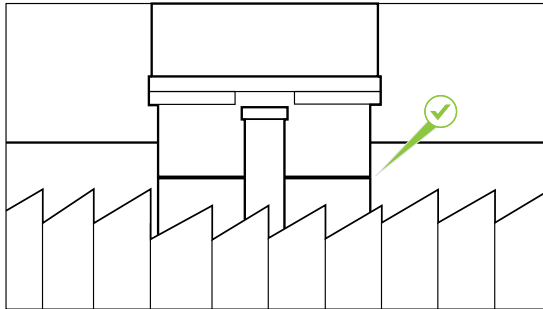

- 4 Installez la carte graphique GeForce RTX 5070 dans le slot primaire PCI Express x16 de votre carte mère.

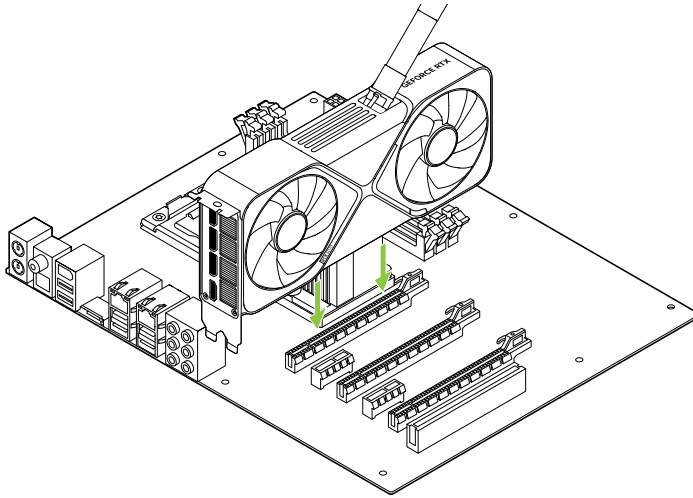

Installez votre première GeForce RTX 5070 dans le slot primaire PCI Express x16 (le slot primaire est celui qui est le plus proche du CPU).



Attention: Cette carte graphique ne doit pas être installée avec les supports d'entrée/sortie orientés vers le bas.

- 5 Reconnectez tout câble précédemment déconnecté et refermez le boîtier de votre ordinateur.

04 Connexion Au Périphérique D'affichage

- 1 Connectez votre (ou vos) périphérique(s) d'affichage sur la carte graphique.
- 2 Reconnectez le câble d'alimentation de votre PC.

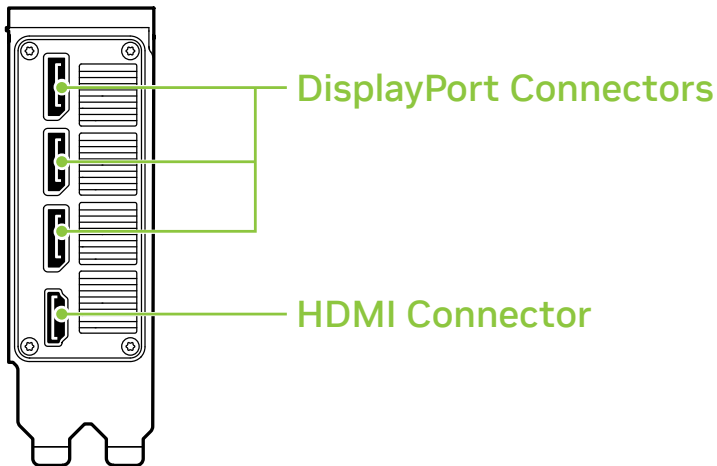

05 Installation Des Logiciels Et Configuration

Une fois le matériel installé, il ne vous reste plus qu'à installer le logiciel NVIDIA App afin de mettre à jour vos pilotes graphiques et d'optimiser vos jeux.

- 1 Téléchargez et installez le logiciel NVIDIA App.
 - Rendez-vous sur <https://www.nvidia.com/fr-fr/software/nvidia-app/> et cliquez sur **TÉLÉCHARGER**.
 - Acceptez l'accord de licence du logiciel NVIDIA en sélectionnant **Accepter et continuer**. La procédure d'installation du logiciel NVIDIA App commence.
 - Sélectionnez **Fermer** pour terminer l'installation.

2 Félicitations ! Votre carte graphique GeForce est prête à l'emploi!



Remarque: Si vous avez la moindre question sur votre produit NVIDIA, vous pouvez contacter directement l'un des conseillers NVIDIA sur www.nvidia.com/support ou au 33 9 75 18 67 97.

01 Requisiti Di Sistema

Grazie per aver scelto una scheda grafica NVIDIA® GeForce RTX™ 5070. Prima di iniziare, per cortesia consultare le specifiche di sistema per assicurarti che il tuo PC abbia l'hardware e il software appropriati per la tua nuova scheda grafica.

Requisiti di sistema

> Scheda madre:

Occorre slot grafico PCI Express.

> Clearance:

Spazio necessario per schede da 244 mm (L) x 112 mm (W) x 41 mm (H). Si consiglia maggiore spazio per lo slot davanti alle ventole per un migliore flusso d'aria.

➤ **Alimentatore di sistema:**

- Potenza nominale minima 650 W.
- Configurazioni del connettore di alimentazione supportate:
 - Almeno due cavi PCIe a 8 pin
(con adattatore per connettore di alimentazione RTX 5070 PCIe Gen 5).
 - Un cavo PCIe Gen 5 da 360 W o superiore (16 pin).

➤ **Operating System:**

- Microsoft® Windows® 11 64-bit raccomandato.
- Linux, 64-bit.

➤ **Installazione del driver:** 2 GB di spazio disponibile su disconnecessari per l'installazione del driver.

02 Accessori

I seguenti accessori sono inclusi nella confezione della scheda grafica NVIDIA GeForce RTX 5070.

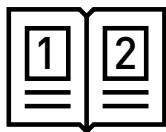

Guida rapida

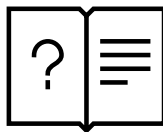

Guida di
supporto

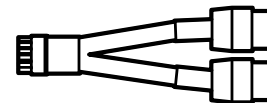

Adattatore per
connettore di
alimentazione NVIDIA
PCIe Gen5 16-pin



Attention: Usa solo l'adattatore per connettore di alimentazione NVIDIA per le schede grafiche GeForce RTX serie 50 Founders Edition.

Connettori di alimentazione
PCIe Gen5 a 16 pin

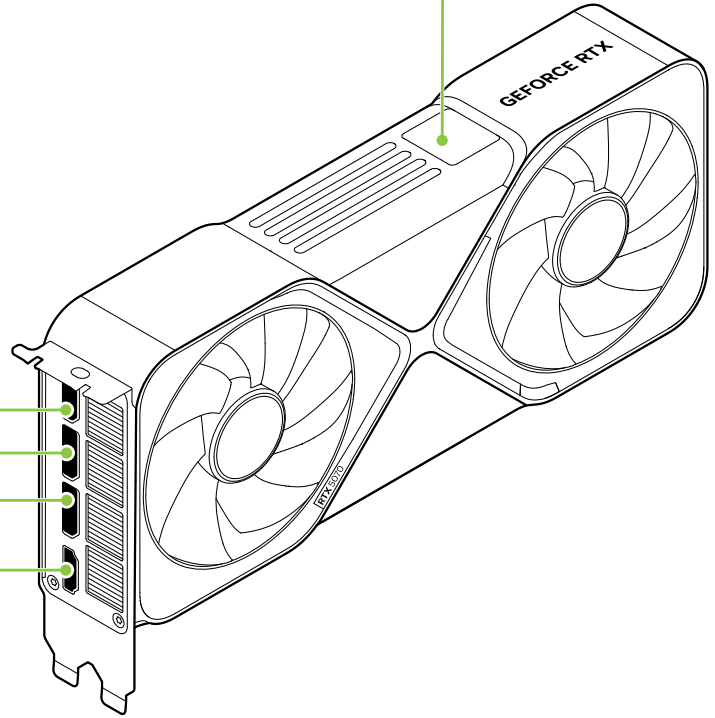
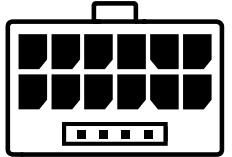

Connettori
DisplayPort (x3)

Connettore HDMI 2.1

Scheda grafica GeForce RTX 5070

03 Installazione Dell'hardware

- 1 Spegnere il computer, scollega il cavo di alimentazione e rimuovi qualsiasi scheda grafica esistente.



Attenzione: è molto importante attendere che la scheda grafica si raffreddi prima di estrarla dal sistema.

- 2 Rimuovi le due coperture dello slot se non c'era già una scheda grafica.

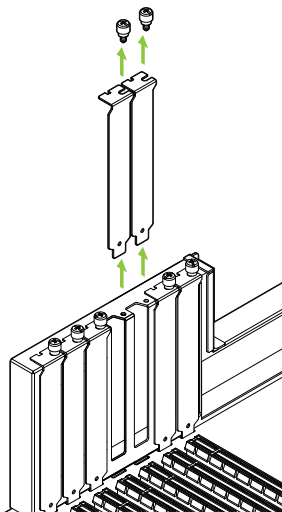

Rimuovi le due coperture dello slot adiacente che corrisponde allo slot PCI Express in cui stai installando la scheda grafica.

- 3** Collega la spina dell'adattatore per connettore di alimentazione NVIDIA a 16 pin alla presa sulla parte superiore della scheda grafica GeForce RTX 5070.

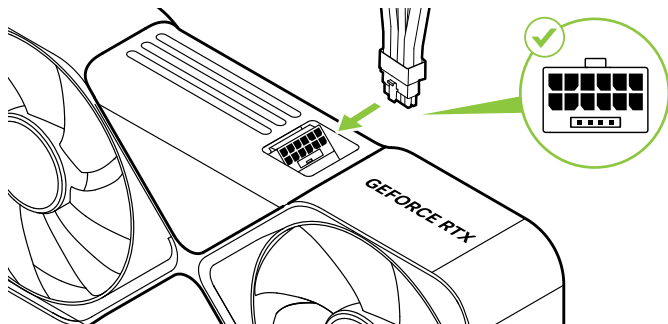

Collega almeno due cavi indipendenti dedicati con spine PCI Express a 8 pin dalla fonte di alimentazione del sistema all'adattatore per connettore di alimentazione NVIDIA.



Attention: Usa solo l'adattatore per connettore di alimentazione NVIDIA per le schede grafiche GeForce RTX serie 50 Founders Edition.

Per garantire che il connettore sia sicuro, ti consigliamo di collegare prima il dongle di alimentazione alla scheda grafica per assicurarti che sia collegato saldamente e in modo uniforme, prima di collegare la scheda grafica alla scheda madre.



Attenzione: Accertarsi che la spina di alimentazione sia completamente inserita e posizionata a filo con la presa di alimentazione.

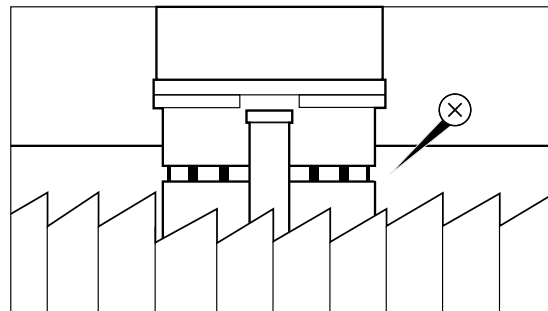
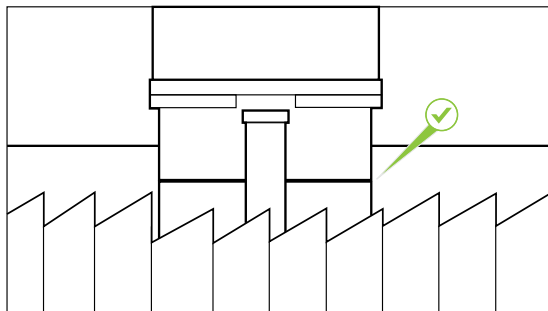

- 4 Installa la tua GeForce RTX 5070 nello slot principale PCI Express x16 della tua scheda madre.

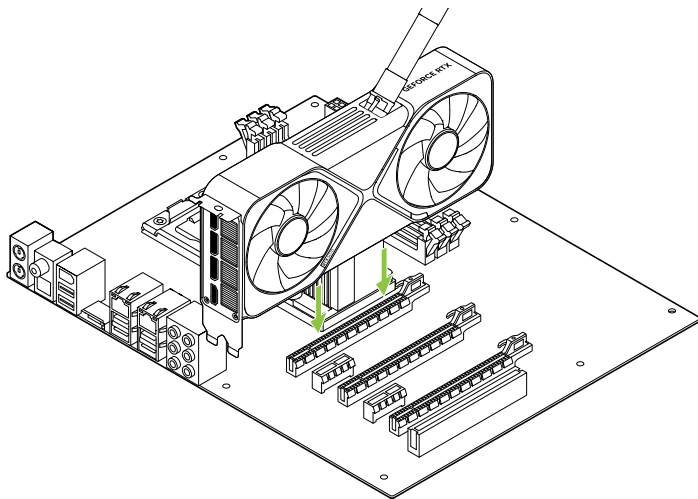

Installa la tua nuova GeForce RTX 5070 nello slot principale PCI Express x16 (lo slot principale e' quello piu' vicino alla CPU).



Attention: La GPU non deve essere installata con le fasce I/O rivolte verso il basso.

- 5 Reinstallare le coperture sul computer e ricollegare eventuali cavi rimossi in precedenza.

04 Collegamento Al Display

- 1 Collegare uno o più display alla scheda grafica.
- 2 Ricollegare il cavo di alimentazione al PC.

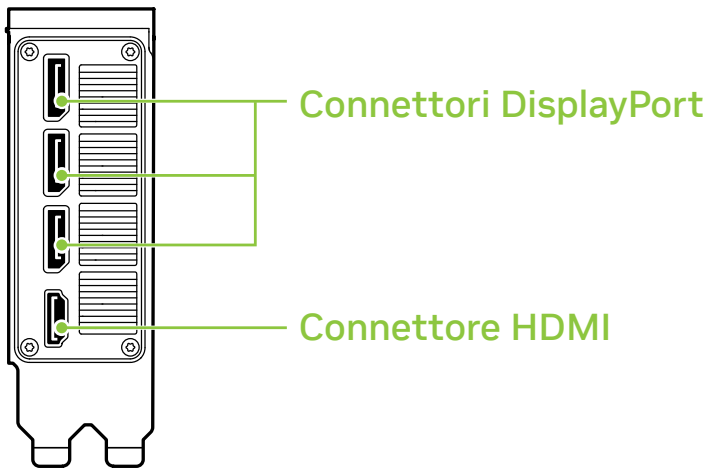

05 Installazione Del Software E Configurazione

Con l'hardware installato, la fase finale consiste nell'installare il software NVIDIA App in modo da aggiornare i driver e ottimizzare i videogame.

1 Download and install NVIDIA App software.

- Visita l'indirizzo <https://www.nvidia.com/it-it/software/nvidia-app/> e fai clic su **Download Now**.
- Accetta l'accordo di licenza software di NVIDIA selezionando **Agree and Continue**. L'installazione del software NVIDIA App ha inizio.
- Seleziona **Close** per finire l'installazione.

2 Congratulazioni! Ora la tua scheda grafica GeForce è pronta per l'uso!



Note: se hai altre domande in merito al tuo prodotto NVIDIA puoi chattare live con il Servizio clienti NVIDIA all'indirizzo www.nvidia.com/support o chiama il numero 39 02 9475 7110.

01 Systemspezifikationen

Vielen Dank, dass Sie sich für eine NVIDIA®-GeForce RTX™-5070-Grafikkarte entschieden haben. Bevor Sie starten, kontrollieren Sie bitte die folgenden Systemspezifikationen, um sicherzustellen, dass Ihr PC die nötigen Hard- und Softwarevoraussetzungen für Ihre neue Grafikkarte erfüllt.

Systemspezifikationen

> **Mainboard:**

PCI-Express®-Grafik-Slot benötigt.

> **Abstand:**

Muss Platz für Karte mit den Maßen 244mm (L) x 112mm (W) x 41mm (H) haben. Für eine bessere Luftzirkulation ist ein zusätzlicher Steckplatz vor den Lüftern zu empfehlen.

- **Systemstromversorgung:**
 - Mindestleistung von 650 W.
 - Unterstützte Stromanschlusskonfigurationen:
 - Mindestens zwei PCIe-8-polige Kabel (mit RTX-5070-PCIe-Gen-5-Netzadapter).
 - Ein PCIe-Gen-5-Kabel mit 360 W oder mehr (16-polig).

- **Operating System:**
 - Microsoft® Windows® 11 64-Bit, empfohlen.
 - Linux, 64-bit.

- **DTreiberinstallation:** Für die Treiberinstallation ist 2 GB freier Speicherplatz erforderlich.

02 Lieferumfang

Der Lieferumfang der Grafikkarte NVIDIA GeForce RTX 5070 umfasst folgende Komponenten:

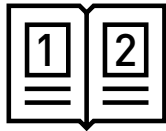

Kurzanleitung

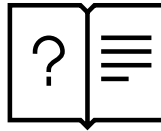

Supportanleitung

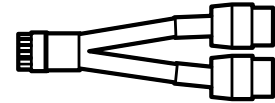

NVIDIA PCIe-
Netzadapter, 16-polig



Achtung: Verwende nur den mitgelieferten NVIDIA-Netz adapter für deine Founders Edition-Grafikkarte der GeForce RTX 50-Serie.

PCIe-Gen-5-16-poliger
Stromanschluss

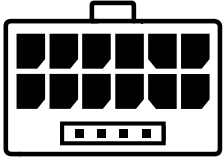

Adapter für
DisplayPort (3x)

Adapter für HDMI

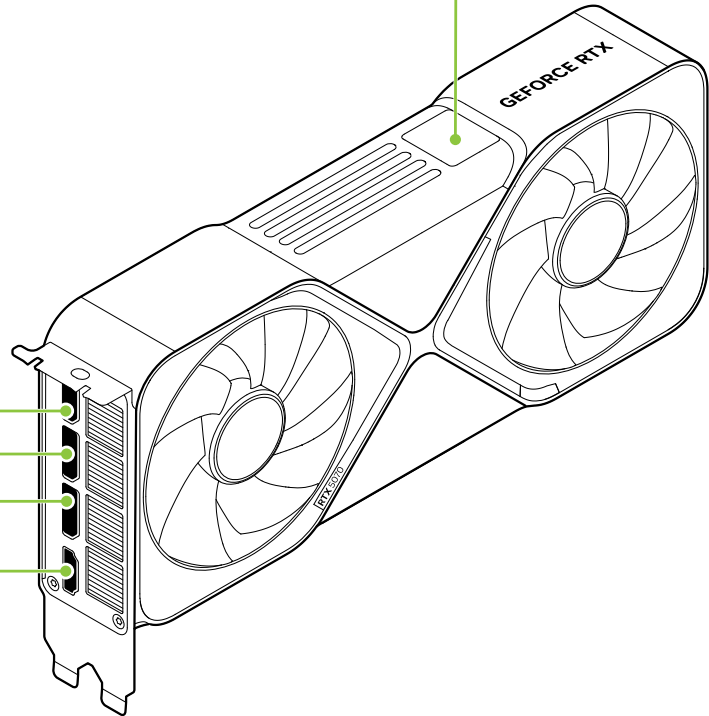

GeForce RTX 5070 Graphics Card

03 Hardwareinstallation

- 1 Den Computer ausschalten, das Netzkabel abtrennen und eventuell installierte Grafikkarten entfernen.



Achtung: Bevor die Grafikkarte aus dem Computer herausgenommen wird, unbedingt solange warten, bis sich die Karte abgekühlt hat.

- 2 Entferne zwei Steckplatzabdeckungen, wenn keine Grafikkarte vorhanden war.

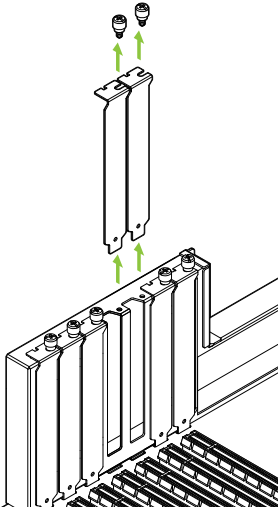

Entferne zwei benachbarte Steckplatzabdeckungen, die dem PCI Express-Steckplatz entsprechen, in dem du die Grafikkarte installierst.

- 3 Stecke den 16-poligen Anschluss des NVIDIA-Netzadapters in die Buchse oberhalb der GeForce RTX 5070-Grafikkarte.

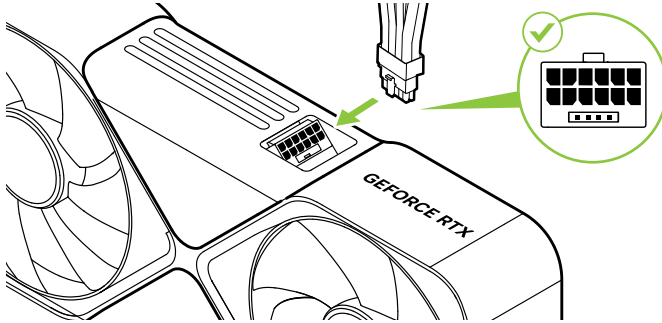

Schließe mindestens zwei unabhängig dedizierte Kabel mit einem 8-poligen PCI-Express-Anschluss vom Systemnetzteil an den NVIDIA-Netzadapter an.



Attention: Verwende nur den mitgelieferten NVIDIA-Netz adapter für deine Founders Edition-Grafikkarte der GeForce RTX 50-Serie.

Um sicherzustellen, dass der Stecker sicher ist, empfehlen wir, zuerst den Power-Dongle in die Grafikkarte zu stecken, um sicherzustellen, dass er fest und gleichmäßig eingesteckt ist, bevor Sie die Grafikkarte in das Motherboard stecken.



Achtung: Stellen Sie sicher, dass der Netzstecker vollständig eingesteckt ist und bündig an der Steckdose anliegt.

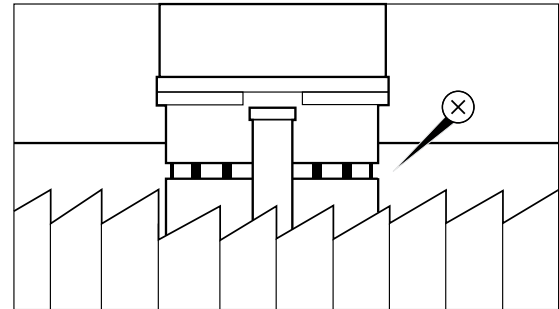
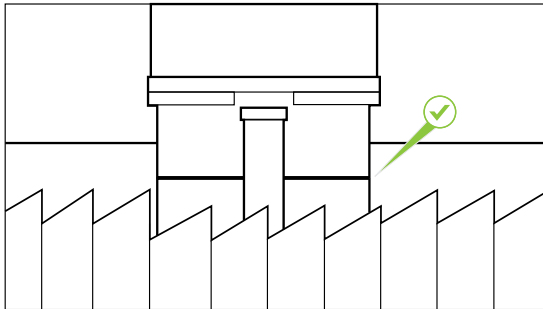

- 4 Installieren Sie die GeForce RTX-5070-Grafikkarte im primären PCI-Express-x16-Steckplatz auf Ihrer Hauptplatine.

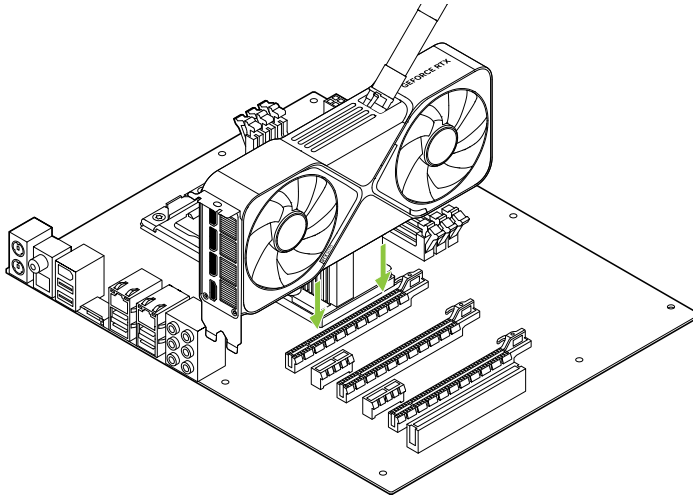

Installieren Sie Ihre GeForce RTX 5070 im primären (Primary) PCI-Express-x16-Steckplatz (der Primary-Steckplatz ist der Steckplatz, der der CPU am nächsten liegt).



Achtung: Die Grafikkarte nicht mit den I/O-Slotblechen nach unten installieren.

- 5 Das Gehäuse wieder am Computer anbringen und eventuell vorher abgetrennte Kabel wieder anschließen.

04 Anschliessen Des Bildschirms

- 1 Den Bildschirm (oder die Bildschirme) an der Grafikkarte anschließen.
- 2 Das Netzkabel wieder am PC anschließen.

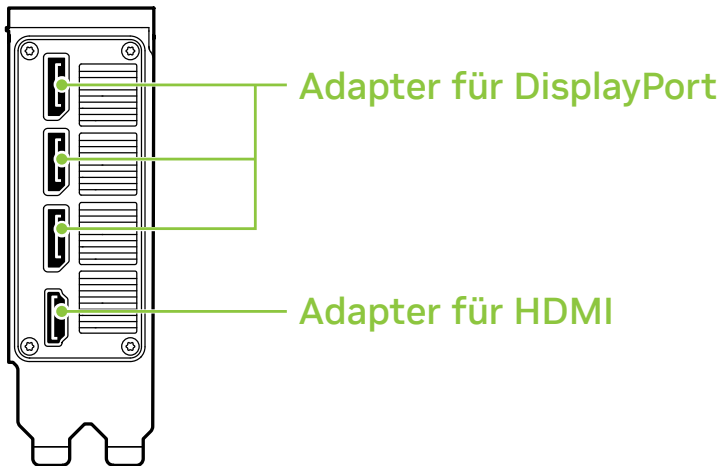

05 Softwareinstallation Und -Konfiguration

Nachdem die Hardware installiert ist, muss jetzt nur noch die Software NVIDIA App installiert werden, damit die Treiber aktualisiert und die Spiele optimiert werden.

- 1 Die Software NVIDIA App herunterladen und installieren.
 - Auf <https://www.nvidia.com/de-de/software/nvidia-app/> gehen und auf **Download Now** (Jetzt herunterladen) klicken.
 - Die NVIDIA-Softwarelizenzvereinbarung durch Markieren von **Agree and Continue** (Zustimmen und fortfahren) akzeptieren. NVIDIA App wird nun installiert.
 - Auf **Close** (Schließen) klicken, um die Installation abzuschließen.

2 Herzlichen Glückwunsch! Ihre GeForce Grafikkarte ist nun einsatzbereit!



Hinweis: Sollten Sie noch Fragen zu Ihrem NVIDIA-Produkt haben, können Sie auf www.nvidia.com/support oder telefonisch über 49 40 30806888 direkt mit dem NVIDIA-Kundendienst sprechen.

01 Especificaciones

Gracias por elegir la NVIDIA® GeForce RTX™ 5070. Antes de comenzar, por favor revisa las siguientes especificaciones para asegurar que tu PC posee el hardware y software necesario para tu nueva tarjeta gráfica.

Especificaciones

> **Placa base:**

Slot gráfico PCI Express requerido.

> **Clearance:**

Debe tener espacio para una tarjeta de 244 mm (L) x 112 mm (A) de 41 mm (Al).

Se recomienda una ranura libre adicional delante de los ventiladores para una mejor circulación de aire.

➤ **System Power Supply:**

- 650 W de potencia mínima.
- Configuraciones de conectores de alimentación compatibles:
 - Como mínimo dos cables PCIe de 8 pines (con adaptador de conector de alimentación RTX 5070 PCIe Gen 5)
 - Un cable PCIe Gen 5 de 360 W o superior (16 pines)

➤ **Sistema operativo:**

- Microsoft® Windows® 11 de 64 bits, recomendado.
- Linux, 64-bit.

➤ **Instalación de controladores:** 2 GB de espacio libre en disco necesario para la instalación del controlador.

02 Documentación Y Accesorios

La caja de la tarjeta NVIDIA GeForce RTX 5070 incluye los siguientes elementos.

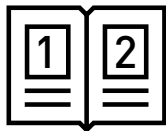

Guía de inicio
rápido

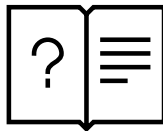

Guía de
soporte

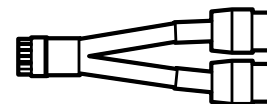

Adaptador de conector
de alimentación PCIe de
5ª generación de 8 pines
de NVIDIA



Atención: Utiliza solo el adaptador de conector de alimentación de NVIDIA incluido para la tarjeta gráfica GeForce RTX serie 50 Founders Edition.

Conector de alimentación
PCIe Gen 5 de 16 pines.

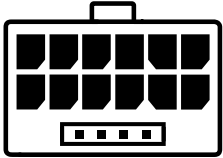

Conectores
DisplayPort (x3)

HDMI Connector

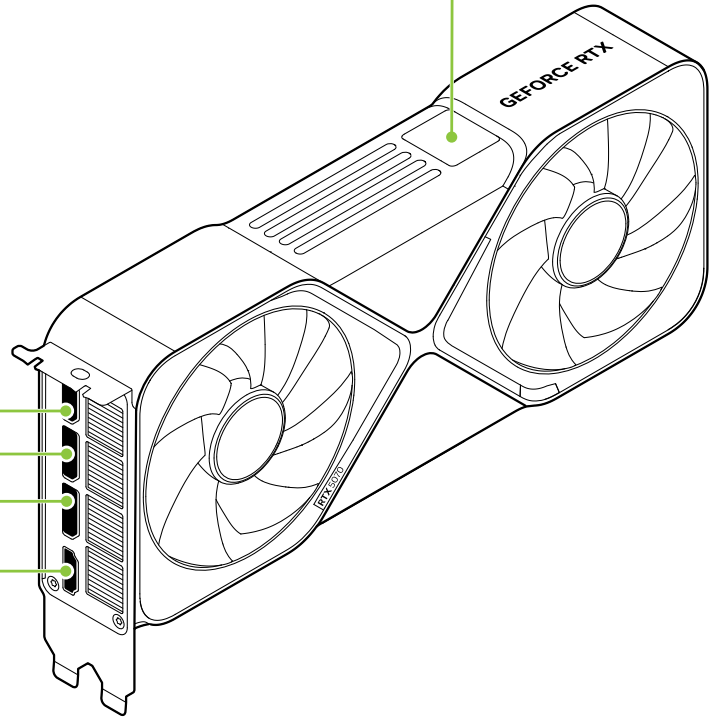

Tarjeta gráfica GeForce RTX 5070

03 Instalación De La Tarjeta

- 1 Apaga el ordenador, desconecta el cable de alimentación y retira cualquier tarjeta gráfica que tenga instalada.



Atención: es muy importante que esperes a que la tarjeta se haya enfriado antes de extraerla del sistema.

- 2 Quita las dos tapas de ranuras si no había una tarjeta gráfica existente.

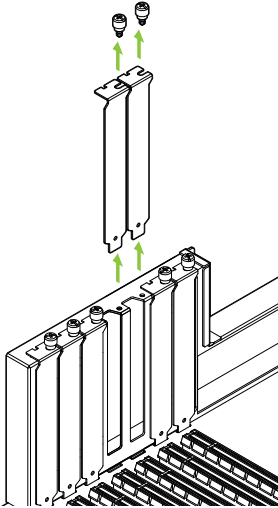

Quita las dos tapas de ranuras adyacentes correspondientes a la ranura PCI Express en la que estás instalando la tarjeta gráfica.

- 3 Conecta el enchufe de 16 pines del adaptador de conector de alimentación NVIDIA al receptáculo de alimentación en la parte superior de la tarjeta gráfica GeForce RTX 5070.

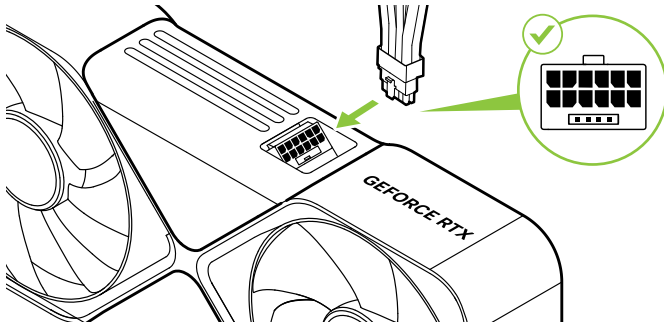

Conecta dos cables dedicados independientes con los conectores PCI Express de 8 pines desde la fuente de alimentación del sistema al adaptador de conector de alimentación de NVIDIA.



Atención: Utiliza solo el adaptador de conector de alimentación de NVIDIA incluido para la tarjeta gráfica GeForce RTX serie 50 Founders Edition.

Para ayudar a garantizar que el conector esté seguro, recomendamos enchufar primero el dongle de alimentación en la tarjeta gráfica para asegurarse de que esté conectado de manera firme y uniforme, antes de enchufar la tarjeta gráfica en la placa base.



Atención: asegúrese de que el enchufe de alimentación esté completamente insertado y asentado al ras contra el receptáculo de alimentación.

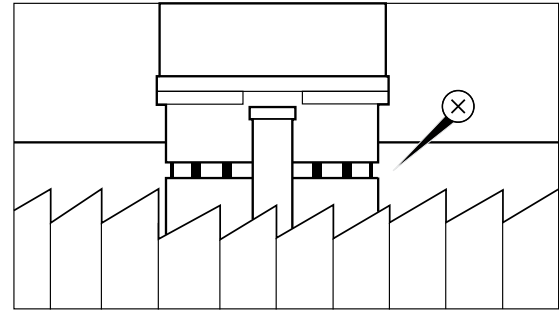
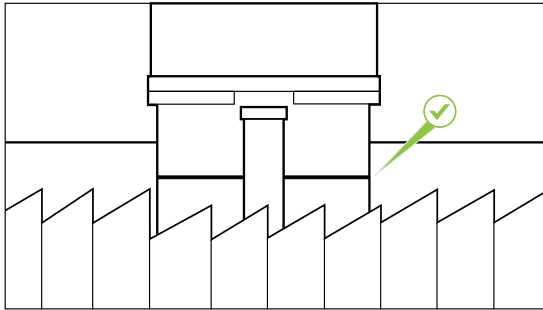

- 4 Instala la GeForce RTX 5070 en el slot PCI-Express x16 primario de tu placa base.

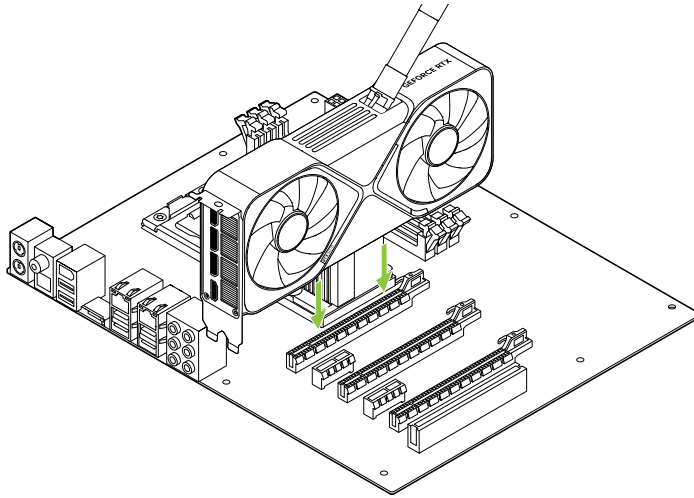

Instala la GeForce RTX 5070 en el slot PCI-Express x16 primario (el slot primario es el más cercano a la CPU).



Atención: Esta tarjeta gráfica no debe instalarse con los soportes de E/S orientados hacia abajo.

- 5 Vuelve a colocar la cubierta del ordenador y a conectar los cables desenchufados con anterioridad.

04 Conexión De La Pantalla

- 1 Conecta la pantalla (o pantallas) a la tarjeta gráfica.
- 2 Vuelve a conectar el cable de alimentación al PC.

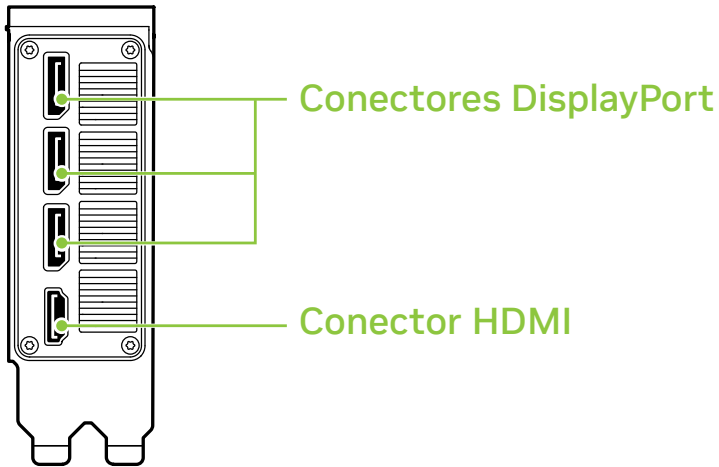

05 Instalación Y Configuración Del Software

Una vez instalada la tarjeta, el último paso es instalar el software NVIDIA App para actualizar los controladores y optimizar tus juegos.

1 Descarga e instala la aplicación NVIDIA App.

- Ve a <https://www.nvidia.com/es-es/software/nvidia-app/> y haz clic en **Descargar ahora**.
- Acepta el acuerdo de licencia del software de NVIDIA seleccionando **Aceptar y continuar**. Se iniciará la instalación de NVIDIA App.
- Haz clic en **Cerrar** para concluir el proceso.

2 ¡Enhorabuena! Tu tarjeta GeForce ya está lista para su uso.



Nota: Si tienes alguna pregunta sobre el producto, puedes hablar por chat con el servicio de atención al cliente de NVIDIA a través de www.nvidia.com/support o llamar al 34 91 1 88 00 35.

01 Системные Спецификации

Благодарим вас за выбор видеокарты NVIDIA® GeForce RTX™ 5070. Перед началом работы настоятельно рекомендуем ознакомиться с системными спецификациями, чтобы убедиться в том, что ваш компьютер соответствует минимальным программным и аппаратным требованиям для работы видеокарты.

Системные спецификации

> Материнская плата:

Необходимо наличие слота PCI Express®.

> Необходимое пространство под видеокарту:

Требуется место для карты размером 244 мм (Д) x 112 мм (Ш) и 41 мм (В). Рекомендуется зазор в один дополнительный слот перед вентиляторами для лучшего воздухообмена.

➤ **Питание:**

- Минимальная номинальная мощность 650 Вт
- Поддерживаемые конфигурации подключения питания:
 - Не менее двух 8-контактных кабелей PCIe (с переходником разъема питания RTX 5070 PCIe Gen 5).
 - Один (16-контактный) кабель PCIe Gen 5, рассчитанный на мощность не менее 360 Вт.

➤ **Операционная система:**

- 64-разрядная версия Microsoft® Windows® 11 (рекомендуется).
- Linux, 64-bit.

➤ **Установка драйвера:** для установки драйвера требуется 2 Гб свободного пространства на диске.

02 Комплектация

В комплекте с видеокартой NVIDIA GeForce RTX 5070 также поставляется:

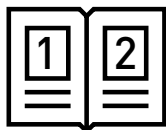

Краткое
руководство
пользователя

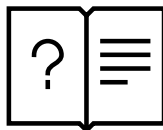

Руководство
по технической
поддержке

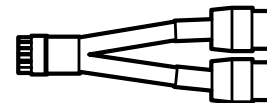

16-контактный
переходник разъема
питания NVIDIA PCIe
Gen5



Важно: Используйте только входящий в комплект переходник NVIDIA для подключения видеокарты GeForce RTX 50 Founders Edition.

16-контактный разъем
питания PCIe Gen 5



Разъемы
DisplayPort (x3)

Разъем HDMI

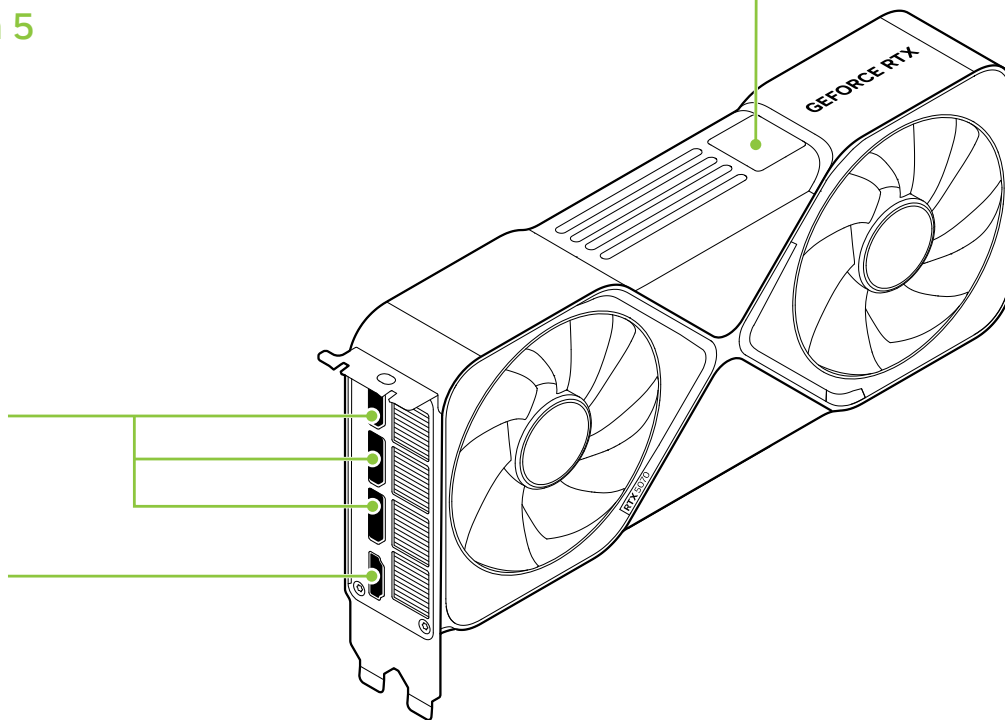

Видеокарта GeForce RTX 5070

03 Установка Оборудования

- 1 Выключите ПК, вытащите шнур питания из розетки и извлеките старую видеокарту(-ы).



Важно: Обязательно дождитесь, пока видеокарта остынет, прежде чем извлекать ее из системы.

- 2 Если до этого в системе не была установлена видеокарта, вытащите две заглушки.

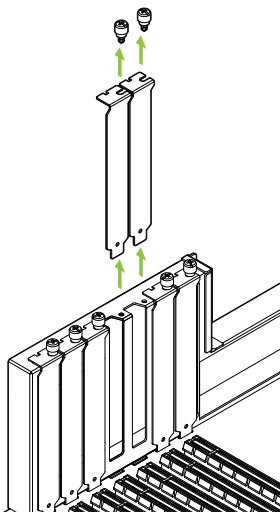

Удалите две заглушки со слота PCI Express, в который вы устанавливаете видеокарту.

- 3 Подключите 16-контактный штекер переходника разъема питания NVIDIA к разъему питания в верхней части видеокарты GeForce RTX 5070.

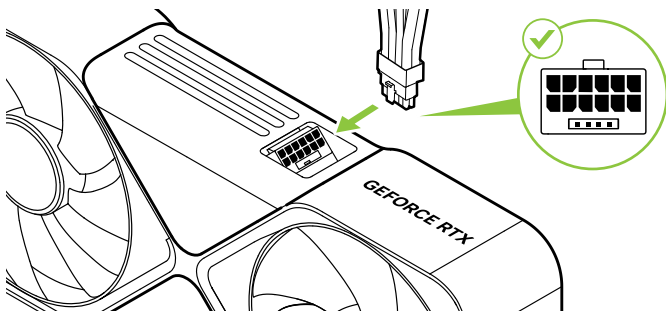

Подключите не менее двух отдельных специальных кабелей с 8-контактными разъемами PCI Express от системного блока питания к переходнику разъема питания NVIDIA.



Важно: Используйте только входящий в комплект переходник NVIDIA для подключения видеокарты GeForce RTX 50 Founders Edition.

Чтобы обеспечить надежность разъема, мы рекомендуем сначала подключить ключ питания к видеокарте, чтобы убедиться, что он надежно и равномерно вставлен, прежде чем подключать видеокарту к материнской плате.



Внимание: Убедитесь, что вилка питания полностью вставлена и плотно прилегает к розетке.

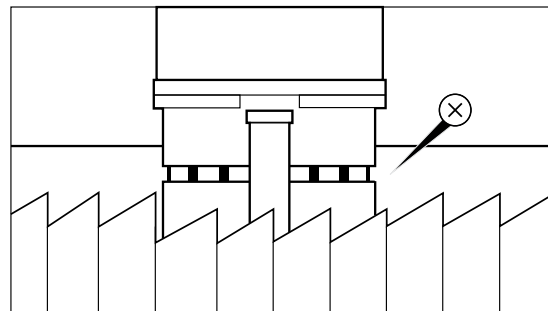
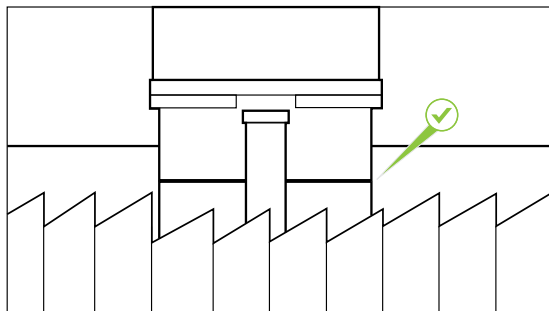

- 4 Установите видеокарту RTX 5070 в первый PCI Express x16 слот на материнской плате.

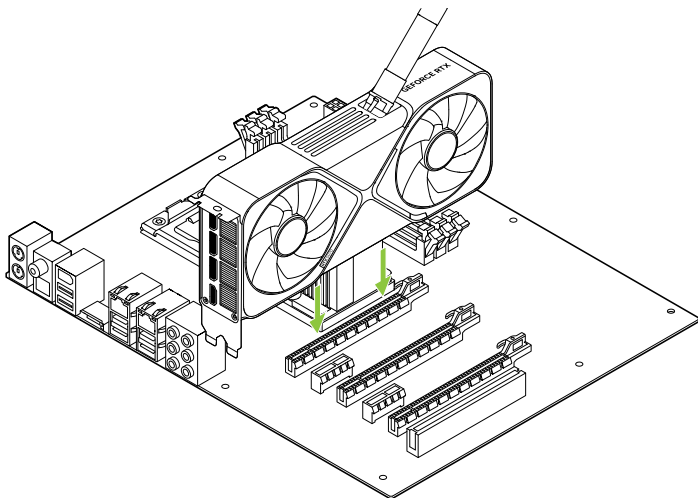

Установите видеокарту RTX 5070 в первый PCI Express x16 слот (первым считается слот, ближе всего расположенный к центральному процессору).



Важно: Не устанавливайте видеокарту в положение, при котором сторона видеовыходов направлена вниз.

- 5 Установите на компьютер крышки и снова подсоедините все ранее отсоединенные кабели.

04 Подключение Дисплея

- 1 Подключите дисплей к видеокарте.
- 2 Подключите шнур питания к ПК.

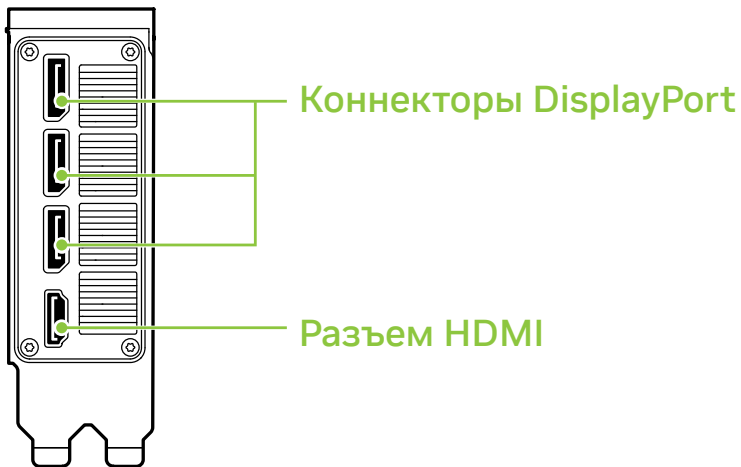

05 Усовершенствование производительности Пярой Игры с помощью NVIDIA App

После установки видеокарты установите приложение NVIDIA App, которое будет автоматически обновлять драйверы вашей видеокарты и оптимизировать игровые настройки.

- 1 Скачайте и установите приложение NVIDIA App.
 - Зайдите на <https://www.nvidia.com/en-us/software/nvidia-app/> и нажмите **Скачать сейчас**.
 - Примите соглашение об использовании лицензионного программного обеспечения NVIDIA, нажав кнопку **Согласиться и продолжить**. Начнется установка приложения NVIDIA App.
 - После завершения установки нажмите **Заккрыть**.

2 Поздравляем! Теперь ваша видеокарта GeForce готова к работе!



Внимание: Если у вас возникли вопросы по продукту, обратитесь в службу технической поддержки NVIDIA на вебсайте www.nvidia.com/support позвоните по тел 1-800-797-6530 (США) или 0800 404 7747 (Великобритания).

01 Specyfikacja Systemu

Dziękujemy za wybranie karty graficznej NVIDIA® GeForce RTX™ 5070. Zanim zaczniesz, zobacz specyfikacje systemu, aby upewnić się, że Twój komputer ma odpowiedni sprzęt i oprogramowanie dla nowej karty graficznej.

Specyfikacja systemu

> **Płyta główna:**

Wymagane gniazdo PCI Express®.

> **Wolna przestrzeń:**

Karta wymaga wolnej przestrzeni o wymiarach 244 × 112 × 41 mm (długość × szerokość × wysokość).

Zalecany jest dodatkowy wolny slot przed wentylatorami, aby zapewnić lepszy przepływ powietrza.

➤ **Zasilanie systemu:**

- Minimalna moc 650 W
- Obsługiwane konfiguracje podłączenia zasilania:
 - co najmniej dwie 8-pinowe kable PCIe (z adapterem zasilania PCIe Gen5 RTX 5070).
 - jeden kabel PCIe Gen5 (16-pinowy) pozwalający dostarczyć moc rzędu 360 W i więcej.

➤ **System operacyjny:**

- Zalecany 64-bitowy system Microsoft® Windows® 11.
- Linux, 64-bit.

➤ **Instalacja sterownika:** 2Do instalacji sterownika wymagane jest 2 GB wolnej przestrzeni na dysku twardym.

02 Składowe Zestawu

Do karty graficznej NVIDIA GeForce RTX 5070 dołączone są następujące elementy wyposażenia.

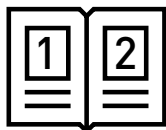

Przewodnik
szybkiego
uruchamiania

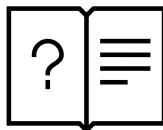

Podręcznik
użytkownika

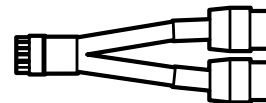

Adapter zasilania
NVIDIA PCIe Gen5
(16-pinowy)



Uwaga: Korzystaj wyłącznie z adaptera zasilania NVIDIA, dołączonego do karty graficznej GeForce RTX z serii 50 Founders Edition.

16-pinowe złącze zasilania
PCIe Gen5



Złącza
DisplayPort (x3)

Złącze HDMI

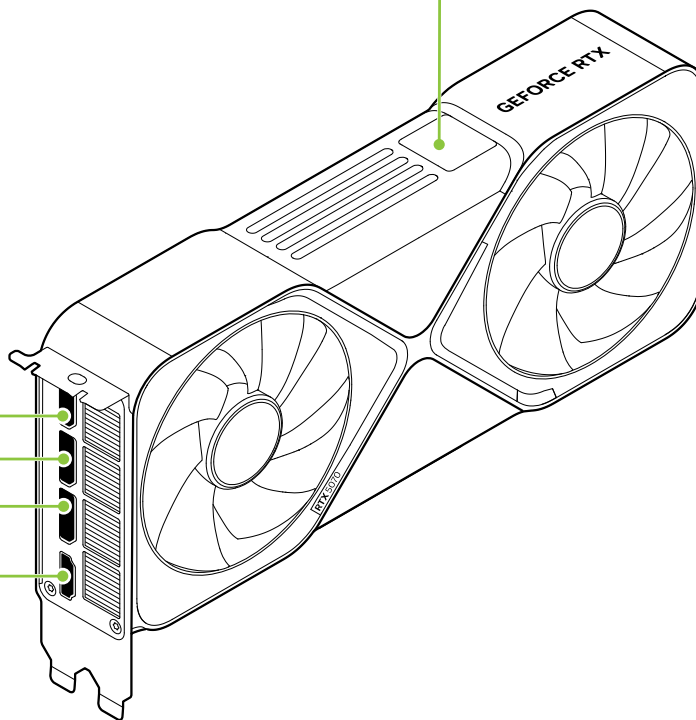

GeForce RTX 5070 Graphics Card

03 Instalacja Sprzętu

- 1 Wyłącz komputer, odłącz przewód zasilający i odłącz obecnie zainstalowaną dedykowaną kartę graficzną (karty graficzne).



Uwaga: przed odłączeniem karty graficznej, koniecznie zaczekaj, aż karta ostygnie.

- 2 Usuń dwie zaślepki slotów, jeśli wcześniej nie zamontowano karty graficznej.

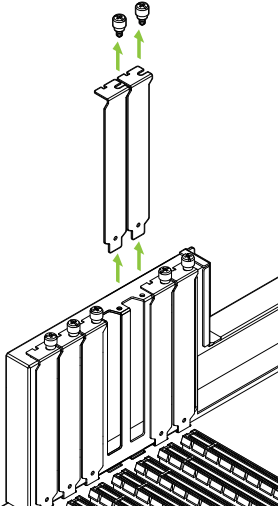

Usuń dwie sąsiadujące zaślepki slotów odpowiadające gniazdu PCI Express, w którym instalujesz kartę graficzną.

- 3 Podłącz 16-pinową wtyczkę adaptera zasilania NVIDIA do gniazda zasilania w górnej części karty graficznej GeForce RTX 5070.

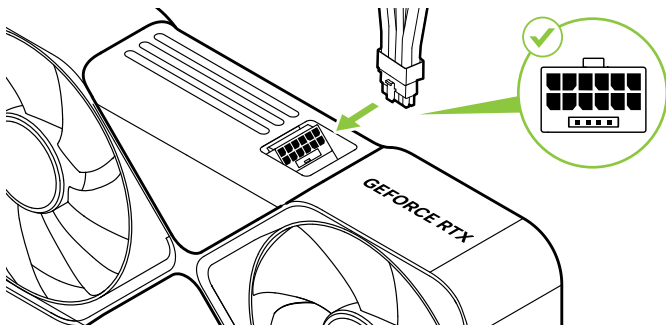

Podłącz do adaptera zasilania NVIDIA co najmniej dwie niezależne, dedykowane kable z 8-pinowymi wtyczkami PCI Express, prowadzące od zasilacza.



Uwaga: Korzystaj wyłącznie z adaptera zasilania NVIDIA, dołączonego do karty graficznej GeForce RTX z serii 50 Founders Edition.

Aby upewnić się, że złącze jest bezpieczne, zalecamy najpierw podłączyć klucz sprzętowy do karty graficznej, aby upewnić się, że jest dobrze i równomiernie podłączony, przed podłączeniem karty graficznej do płyty głównej.



Uwaga: Upewnij się, że wtyczka zasilania jest całkowicie włożona i osadzona równo z gniazdem zasilania.

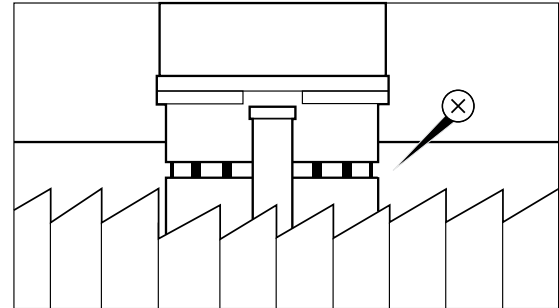
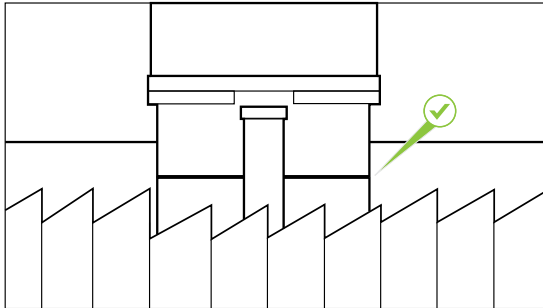

- 4 Zainstaluj kartę graficzną GeForce RTX 5070 w głównym gnieździe PCI Express x16 na płycie głównej.

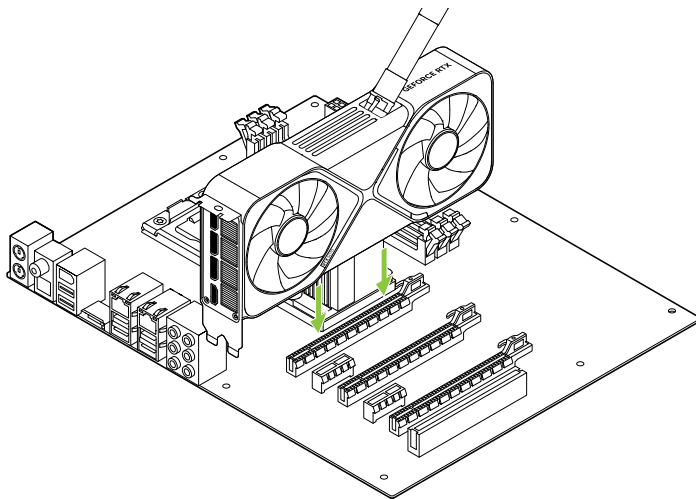

Zainstaluj swoją kartę GeForce RTX 5070 w gnieździe głównym PCI Express x16 (gniazdo główne jest najbliższe procesora).



Uwaga: Tej karty graficznej nie należy montować śledziem skierowanymi w dół.

- 5 Ponownie załóż osłony w swoim komputerze i podłącz no nowo wszelkie podłączone wcześniej kable.

04 Podłączanie Wyświetlacza

- 1 Podłącz wyświetlacz(e) do karty graficznej.
- 2 Ponownie podłącz kabel zasilający do komputera.

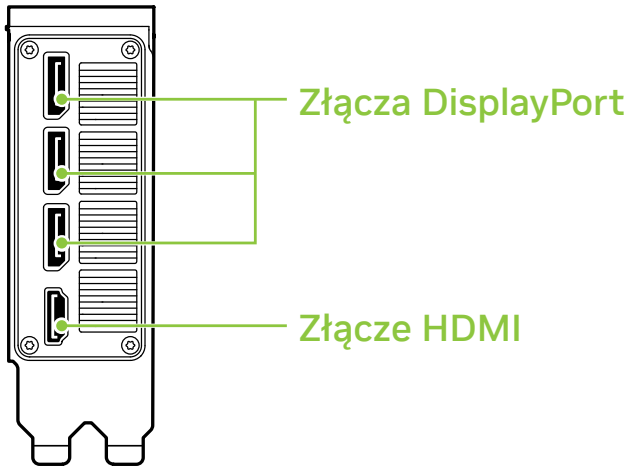

05 Instalacja Oprogramowania I Konfiguracja

Po zainstalowaniu sprzętu, ostatnim krokiem jest instalacja oprogramowania NVIDIA App, które pozwoli Ci aktualizować sterowniki i optymalizować ustawienia w Twoich grach.

- 1 Pobierz i zainstaluj oprogramowanie NVIDIA App.
 - Przejdź na stronę <https://www.nvidia.com/pl-pl/software/nvidia-app/> i kliknij przycisk **Pobierz teraz**.
 - Zaakceptuj umowę licencyjną oprogramowania NVIDIA wybierając opcję **Akceptuj i kontynuuj**. Rozpocznie się instalacja oprogramowania NVIDIA App.
 - Wybierz opcję **Zamknij**, aby dokończyć instalację.

2 Gratulacje! Twoja karta graficzna GeForce jest teraz gotowy do użycia!



Uwaga: Jeśli masz jakiegokolwiek pytania odnośnie produktu NVIDIA, możesz porozmawiać na żywo z pracownikiem Działu Obsługi Klienta NVIDIA na stronie www.nvidia.com/support lub zadzwonić pod numer 48 22 397 50 13.

01 系统参数

感谢您选购 NVIDIA® GeForce RTX™ 5070 显卡。在开始使用之前, 请查看以下系统参数以确保您电脑的软件和硬件符合新显卡的需求

系统参数

- > **主板:**
主板需要支持 PCI Express® 显卡插槽。
- > **主板规格(意指主板上插槽间距尺寸):**
必须为 244mm (L) x 112mm (W) x 41mm (H) 的显卡预留出安装空间, 建议在风扇前多留一个插槽的空间, 以获得更好的气流。

> **系统电源:**

- 最低额定功率 650 W
- 支持的电源接口规格
 - 至少两个独立的 8-Pin PCIe 电源线
(搭配 RTX 5070 第 5 代 PCIe 电源接口转接线)
 - 一根支持 360 W 及以上的第 5 代 PCIe 16-Pin 电源线

> **操作系统:**

- 推荐使用 Microsoft® Windows® 11 64 位
- Linux, 64 位。

> **驱动程序安装:** 需要至少 2GB 硬盘空间安装驱动。

02 设备

以下设备包含在 NVIDIA GeForce RTX 5070 显卡包装盒内。

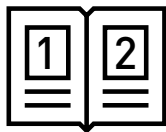

快速入门指南

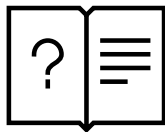

支持指南

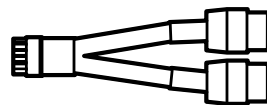

NVIDIA PCIe Gen5 16
针电源插口适配器



注意: GeForce RTX 50 系列 Founders Edition 显卡需搭配包装内电源接口适配器使用。

第 5 代 PCIe 16-Pin
电源接口适配器 (转接线)



DisplayPort
接口 (x3)

HDMI 接口

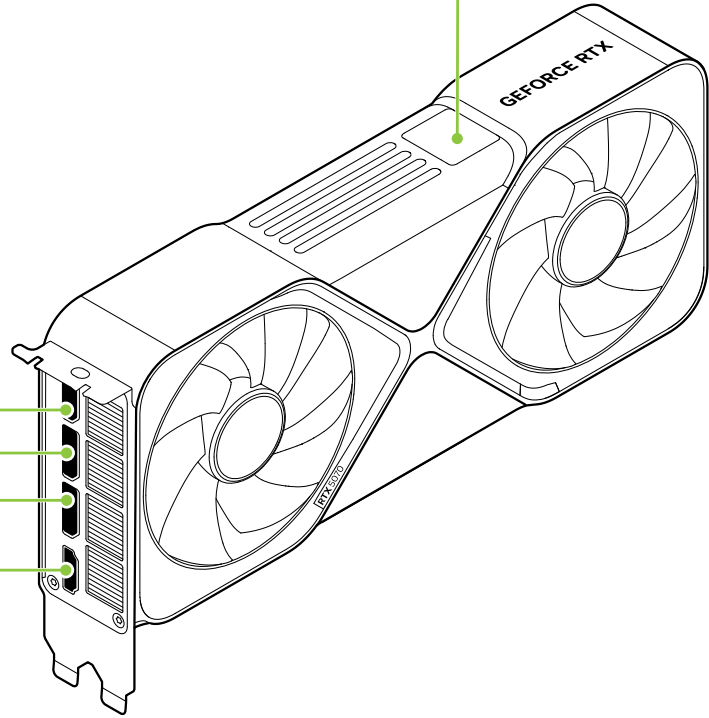

GeForce RTX 5070 Graphics Card

03 硬件安装

- 1 关闭电脑, 断开电源线并移除所有现有显卡。



注意: 请务必等显卡冷却后再将其从系统中取出。

2 在未安装显卡的情况下,如有 PCI Express 插槽盖,请取下两个插槽盖。

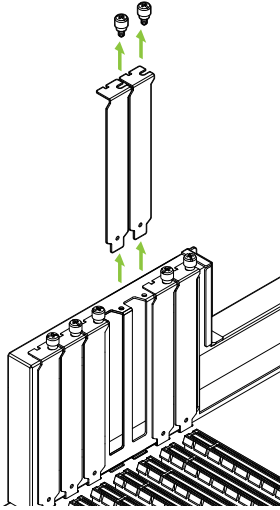

移除对应于您要安装显卡的 PCI Express 插槽的两个相邻插槽盖

- 3 将 NVIDIA 电源接口适配器的 16-Pin 插头接入位于 GeForce RTX 5070 显卡上方的电源接口。

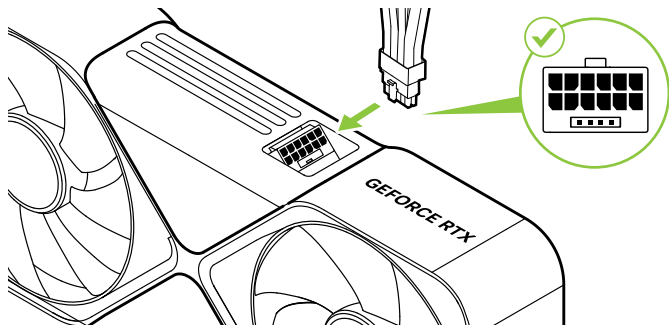

将系统电源连接到至少两个独立 8-Pin 电源线与 NVIDIA 电源适配器 (转接线) 连接



注意: GeForce RTX 50 系列 Founders Edition 显卡需搭配包装内电源接口适配器使用

为帮助确保连接器稳固,我们建议先将电源加密狗插入显卡以确保其牢固均匀地插入,然后再将显卡插入主板。



注意:确保电源插头完全插入并与电源插座齐平。

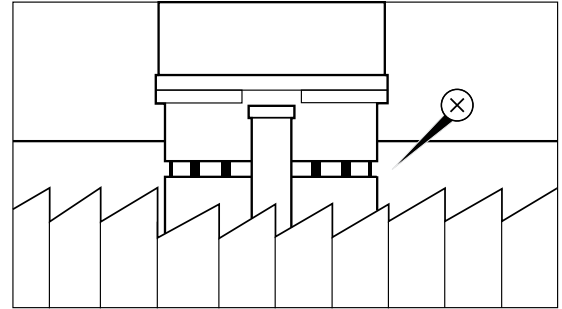
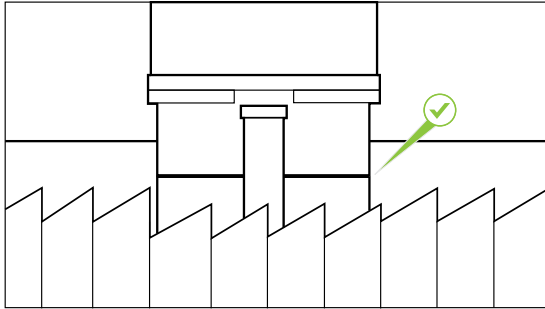

4 将 GeForce RTX 5070 安装至主板上的主 PCI Express x16 插槽。

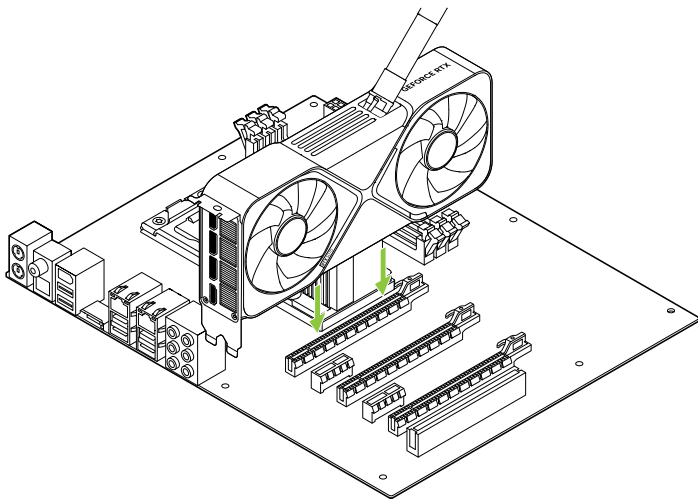

将 GeForce RTX 5070
安装至主 PCI Express x16
插槽 (主插槽位于最接近 CPU
的位置)



注意: 安装此 GPU 产品时, 请勿将 I/O 背板朝下。

5 将插槽盖装回去, 然后重新连接好之前拔下的所有线缆

04 连接显示器

- 1 连接显示器与显卡。
- 2 重新将电源线连接至 PC。

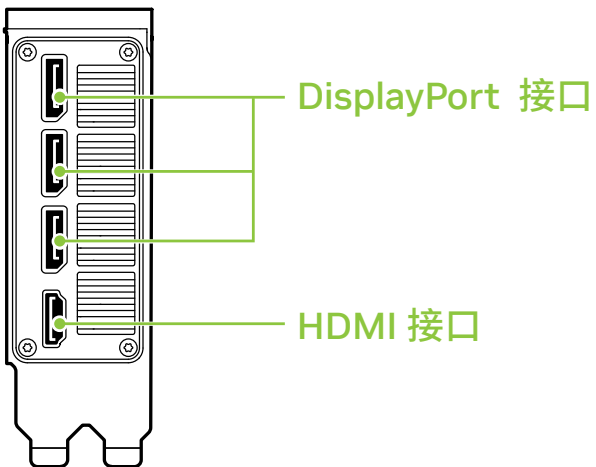

05 软件安装与配置

安装完硬件后,最后一步是安装 NVIDIA App 件来更新 驱动程序并优化游戏体

1 下载并安装 NVIDIA App 软件。

- 转至 <https://www.nvidia.cn/software/nvidia-app/>, 然后单击“**Download Now**” (立即下载)。
- 选择“**Agree and Continue**” (同意并安装), 接受 NVIDIA 软件许可协议。NVIDIA App 软件即开始安装。
- 选择“**Close**” (关闭) 完成安装。

2 恭喜!您现在可以使用 GeForce 显卡了!



注意: 如果您对 NVIDIA 产品有任何疑问, 请访问 www.nvidia.com/support 与 NVIDIA 客户服务团队进行实时聊天。

01 系統規格

感謝您選擇 NVIDIA® GeForce RTX™ 5070 顯示卡。在您開始使用前，請先閱讀系統規格以確保您的電腦有合適的硬體與軟體可使用您的新顯示卡。

系統参数

- > **主板:**
主板需要支持 PCI Express® 显卡插槽。
- > **主板规格(意指主板上插槽间距尺寸):**
必須為 244mm (L) x 112mm (W) x 41mm (H) 的顯示卡留出安裝空間。
建議在風扇前多留一個插槽間隙，以獲得更好的氣流。

> **系統電源:**

- 最低 650 W 額定功率
- 支持的電源連接器配置：
 - 至少兩個 PCIe 8 針電線
(使用 RTX 5070 PCIe Gen 5 電源插座轉接器)。
 - 一條 360 W 或更大的 PCIe Gen 5 電線(16 針)。

> **操作系統:**

- 推薦 Microsoft® Windows® 11 64 位元。
- Linux, 64 位元。

> **驅動程式安裝:** 連接 NVIDIA 電源連接轉接器的 16 針插頭，連接到 GeForce RTX 5070 顯示卡頂部的電源插座。

02 設備

NVIDIA GeForce RTX 5070 繪圖卡盒內包含以下設備。

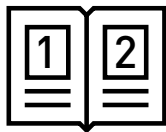

快速入門指南

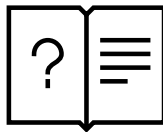

支援指南

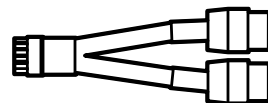

NVIDIA PCIe Gen5 16
針電源插座轉接器



請注意: GeForce RTX 50 系列 創始版顯示卡僅能搭配 NVIDIA 電源連結轉接頭。

PCIe Gen5 16 針電源插座



DisplayPort
接頭 (x3)

HDMI 接頭

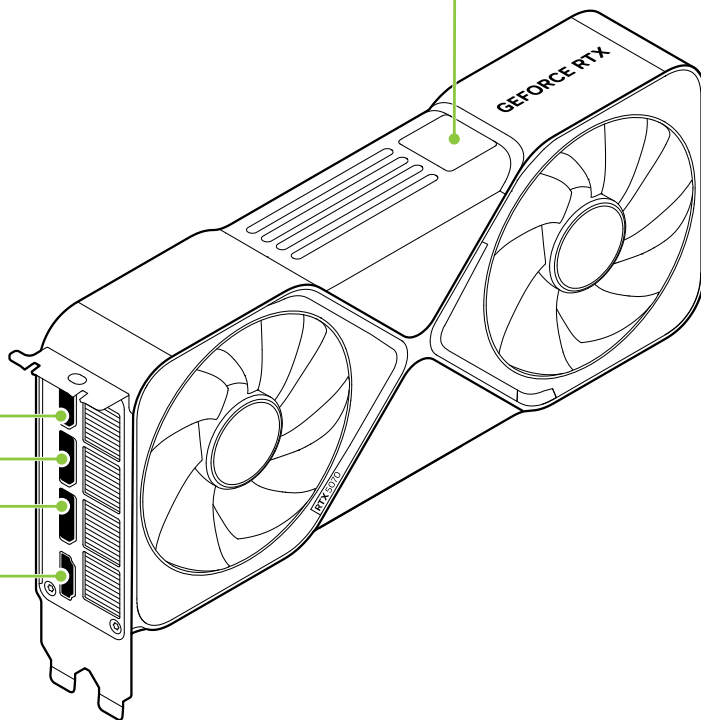

GeForce RTX 5070 繪圖卡

03 硬體安裝

- 1 關閉電腦，拔除電源線，並移除任何現有的繪圖卡。



請注意: 請等待繪圖卡冷卻後，再移除主機中的繪圖卡，這一點很重要。

2 如果沒有現有的顯示卡，請取下兩個插槽蓋。

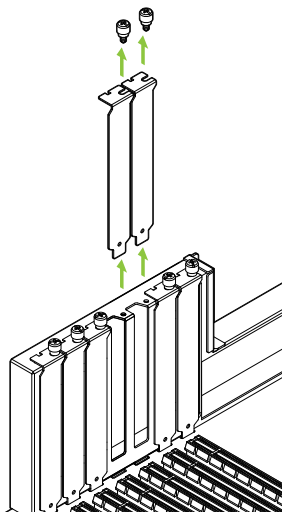

移除您要安裝顯示卡的 PCI Express 插槽與
旁邊兩個相鄰插槽的保護蓋

- 3 連接 NVIDIA 電源連接轉接器的 16 針插頭，連接到 GeForce RTX 5070 顯示卡頂部的電源插座。

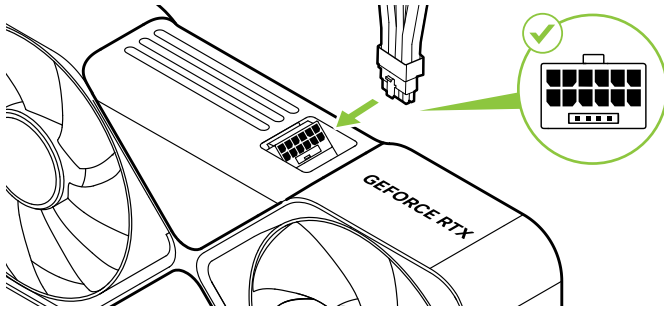

至少放兩條帶 8 針 PCI Express 插頭的獨立專用電線從系統電源連接到 NVIDIA 電源連接轉接器



請注意: GeForce RTX 50 系列 創始版顯示卡僅能搭配 NVIDIA 電源連結轉接頭。

為幫助確保連接器穩固，我們建議先將電源加密狗插入顯卡以確保其牢固均勻地插入，然後再將顯卡插入主板。



注意：確保電源插頭完全插入並與電源插座齊平。

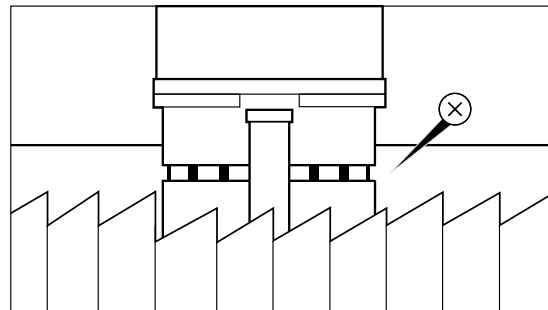
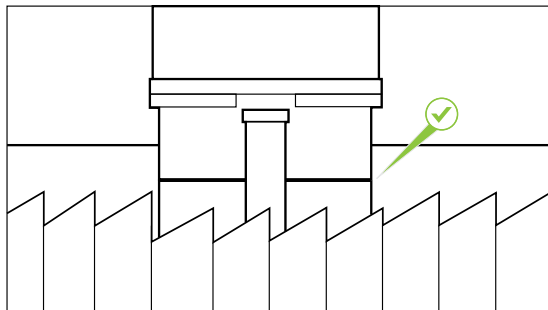

4 在主機板上將您的 GeForce RTX 5070 安裝到主要 PCI Express x16 插槽。

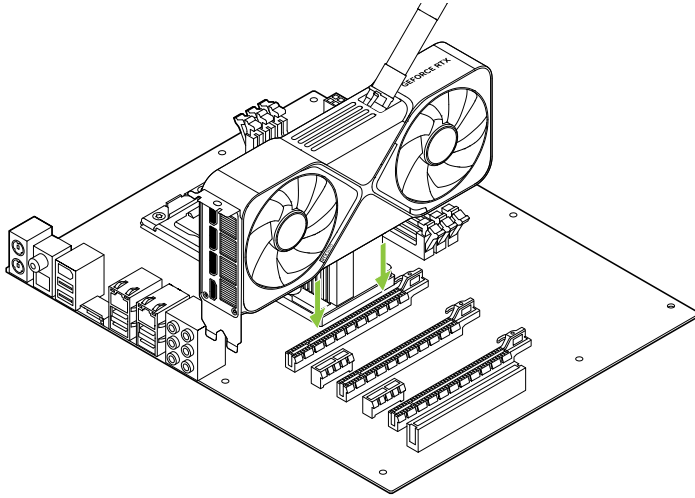

將您的 GeForce RTX 5070 安裝到主要 PCI Express x16 插槽 (最靠近 CPU 的 x16 插槽為主要插槽)。



請注意: 安裝此 GPU 卡, 請勿將 I/O 背板朝下。

5 將電腦機殼蓋板裝回, 並重新接上之前拔除的所有纜線。

04 連接顯示器

- 1 連接顯示器與繪圖卡。
- 2 將 PC 的電源線接上。

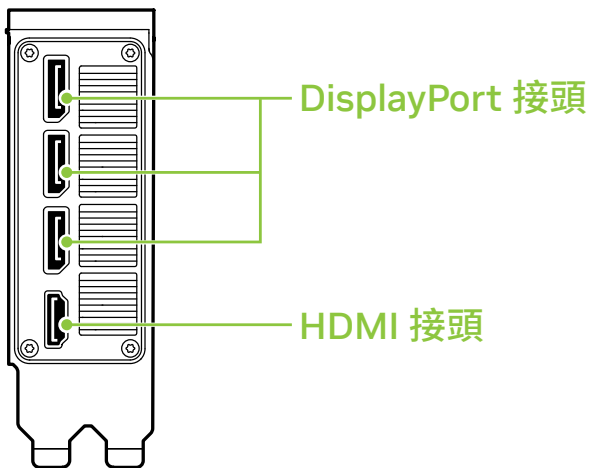

05 應用軟體安裝與設定

硬體安裝完成後，最後的步驟就是安裝 NVIDIA App 應用軟體，以便您更新驅動程式並將遊戲最佳化。

1 Download and install NVIDIA App software.

- 請前往 <https://www.nvidia.com/zh-tw/software/nvidia-app/>，按一下 **[立即下載]**。
- 選取 **[同意並繼續]** 接受 NVIDIA 同意並安裝。NVIDIA App 應用軟體隨即開始安裝。
- 選取 **[Close] (關閉)** 完成安裝。

2 恭喜您！您現在即可開始使用 GeForce 繪圖卡！



備註：若您對於 NVIDIA 產品有任何疑問，可至 www.nvidia.com/support 線上詢問 NVIDIA 客戶服務人員。

01 システム仕様

NVIDIA® GeForce RTX™ 5070 グラフィックスカードをご購入頂きありがとうございます。ご使用を開始する前にお使いのパソコンに適切なハードウェアとソフトウェアが搭載されているかシステム仕様をご確認ください

システム仕様

> マザーボード:

PCI Express® グラフィックススロットが必要です

> クリアランス:

244mm (L) x 112mm (W) x 41mm (H) のグラフィックスカード設置スペースが必要です。また、より良いエアフローを確保するために、ファンの前にもう1つのスロットを空けることを推奨します。

> **システム電源:**

- 最小定格電力 650 W
- 対応する電源コネクタの構成。
 - 少なくとも 2 つ PCIe 8 ピン ケーブル (RTX 5070 PCIe Gen 5 電源コネクタアダプタ使用時)
 - 1 本の 360W 以上の PCIe Gen 5 ケーブル (16 ピン)

> **オペレーティングシステム:**

- Microsoft® Windows® 11 64ビットを推奨
- Linux, 64ビット。

> **ドライバのインストール:** ドライバをインストールする為にはディスクに 2GB 以上の空き領域が必要です。

02 付属品

NVIDIA GeForce RTX 5070 グラフィックスカードには、以下の付属品が同梱されています。

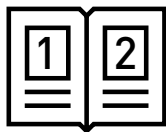

クイック
スタートガイド

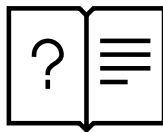

サポート
ガイド

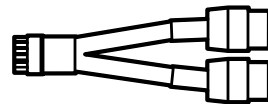

NVIDIA PCIe Gen5 16
ピン電源コネクタアダプタ



注意: GeForce RTX 50 シリーズ ファウンダーズエディション グラフィックスカードには、付属の NVIDIA 電源コネクタアダプタのみをご使用ください。

PCIe Gen 5 16
ピン 電源コネクタ

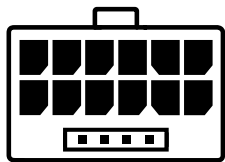

ディスプレイポート
コネクタ (3個)

HDMIコネクタ

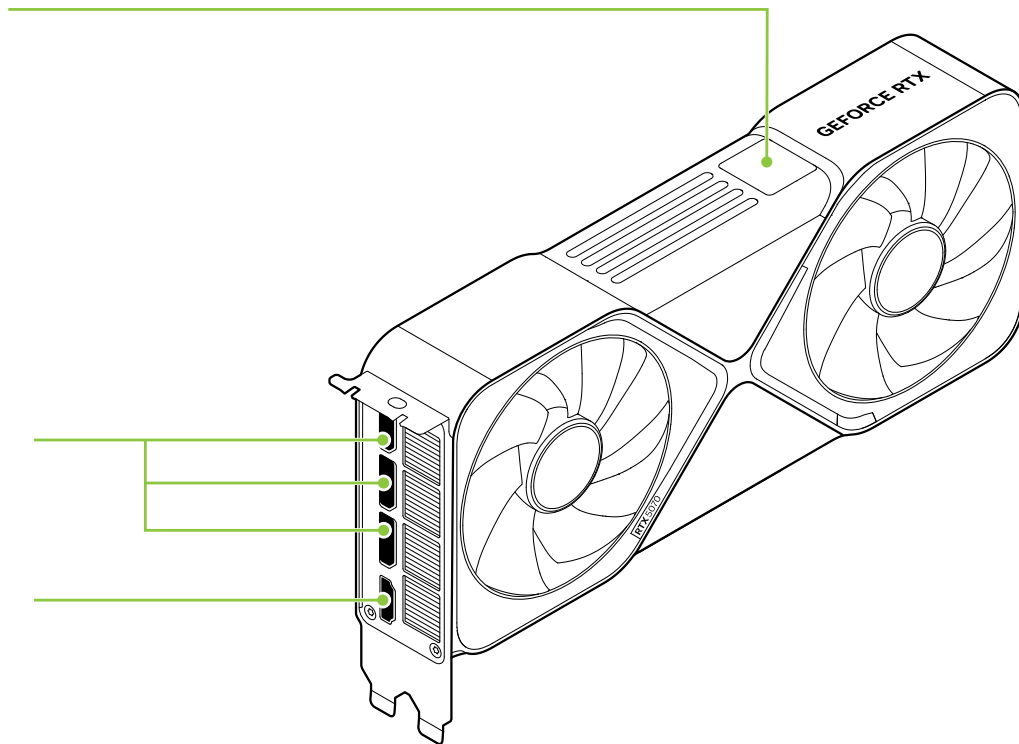

GeForce RTX 5070 グラフィックスカード

03 ハードウェアのインストール

- 1 コンピュータの電源をオフにして、電源コードを抜き、すでにインストールされているグラフィクスカードを取り外します。



注意: グラフィックカードの温度が十分に下がったのを確認し、グラフィクスカードをシステムから取り外してください

- 2 既にグラフィックスカードをインストールしていない場合は、2つのスロットカバーを取り外します。

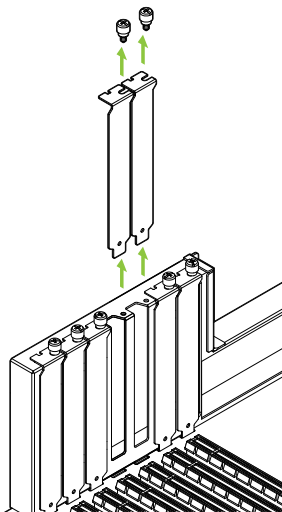

グラフィックスカードをインストールする為に、2つの隣接する PCI Express スロットのスロットカバーを外します。

- 3 NVIDIA 電源コネクタアダプタの 16 ピンプラグを GeForce RTX 5070 グラフィックスカード上部の電源リセプタクルに接続します。

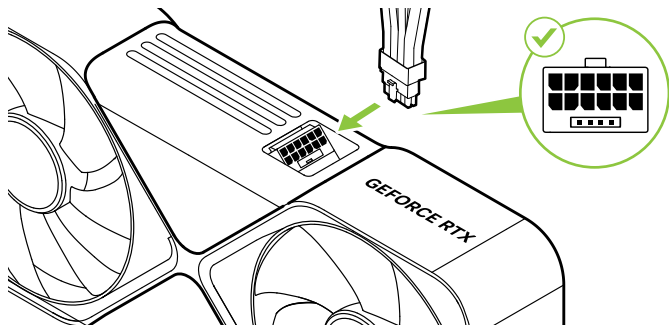

システム電源から NVIDIA 電源コネクタアダプタまで、少なくとも2つの独立した専用もあります 8 ピン PCI Express プラグの専用ケーブルを接続します。



注意: GeForce RTX 50 シリーズ ファウンダーズエディション グラフィックスカードには、付属の NVIDIA 電源コネクタアダプタのみをご使用ください。

コネクタが確実に固定されるように、グラフィックスカードをマザーボードに差し込む前に、まず電源ドングルをグラフィックスカードに差し込んで、しっかりと均等に差し込まれていることを確認することをお勧めします。



重要: 電源プラグが完全に挿入され、電源コンセントに対して平らに取り付けられていることを確認してください。

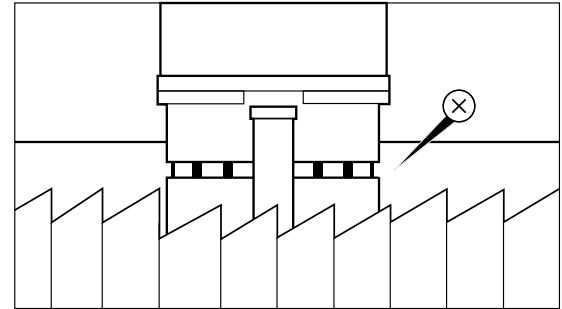
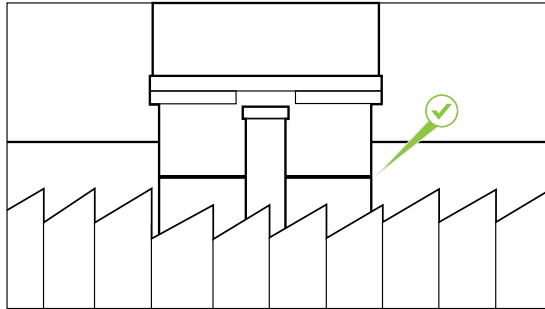

4 GeForce RTX 5070 グラフィックスカードをマザーボード上のプライマリ PCI Express x16 スロットにインストールします

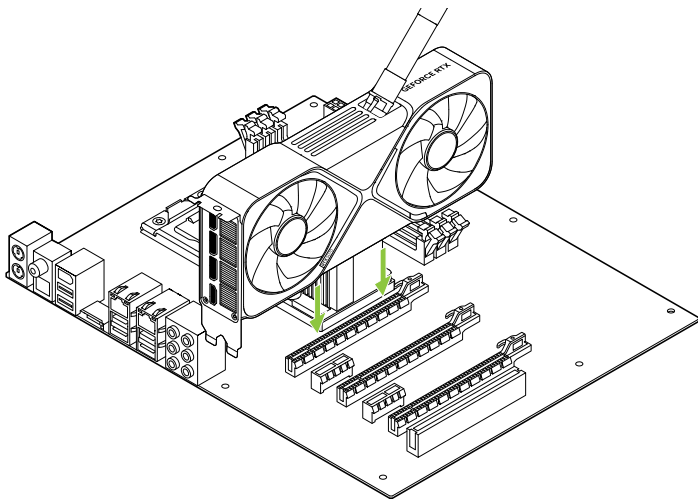

GeForce RTX 5070 をプライマリ PCI Express x16 スロットにインストールします (プライマリ スロットは CPU に最も近いスロットです)



注意: このグラフィックス カードの I/O ブラケットを下向きにして取り付けないでください。

5 コンピュータのカバーを取り付け、取り外したすべてのケーブルを接続し直します

04 ディスプレイとの接続

- 1 ディスプレイをグラフィックスカードに接続します。
- 2 電源コードをパソコンに接続し直します。

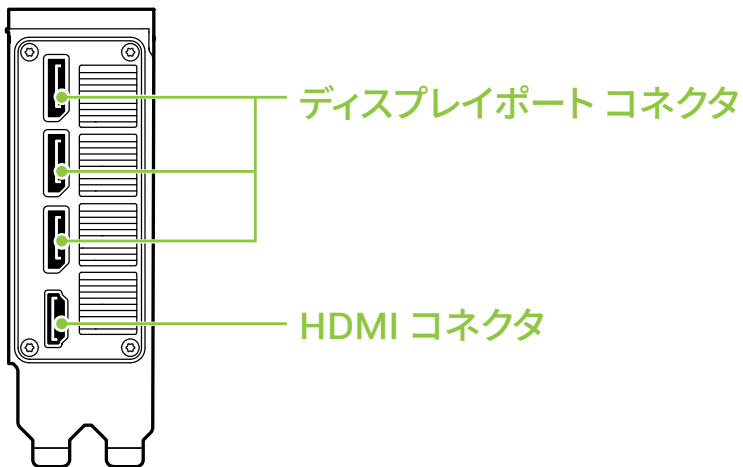

05 ソフトウェアのインストールと設定

ハードウェアを取り付けたら、最後のステップとして、NVIDIA App ソフトウェアをインストールしてドライバを更新し、ゲームを最適化します。

- 1 NVIDIA App ソフトウェアをダウンロードしてインストールします
 - <https://www.nvidia.com/ja-jp/software/nvidia-app/> にアクセスして **[今すぐダウンロードする]** をクリックします。
 - **[同意して続行する]** を選択して、NVIDIA ソフトウェアライセンス契約を受け入れます。NVIDIA App ソフトウェアのインストールが開始されます
 - **[閉じる]** を選択して、インストールを終了します。
- 2 おめでとうございます。ソフトウェアのインストールと設定が完了しました。



メモ: NVIDIA 製品に関する質問については、www.nvidia.com/support で NVIDIA カスタマーケアとチャットにてお問合せ頂けます。

01 시스템 사양

NVIDIA® GeForce RTX™ 5070 그래픽 카드를 구매해 주셔서 감사합니다.
제품을 사용하기 전, 새 그래픽 카드에 적합한 하드 웨어 및 소프트웨어가 PC 에
설치되어 있는지 다음 시스템 사양 을 통해 확인하십시오.

시스템 사양

> 머더보드:

PCI Express® 그래픽 슬롯이 필요합니다

> 여유 공간:

244mm (L) x 112mm (W) x 41mm (H) 카드를 장착할 공간이
있어야 합니다. 공기 흐름을 개선시키기 위해 팬 앞에 슬롯 간극이 하나
더 있는 것이 좋습니다

> **시스템 전원 공급 장치:**

- 최소 650 W 정격 전력
- 지원되는 전원 커넥터 구성:
 - 최소 2 PCIe 8-pin 케이블 (RTX 5070 PCIe Gen 5 전원 커넥터 어댑터).
 - 360 W 이상의 PCIe Gen 5 케이블 1개 (16-pin).

> **Operating System:**

- Microsoft® Windows® 11 64-bit, 권장 혹은
- Linux, 64 비트.

> **드라이버 설치:** 드라이버 설치에 2GB 의 사용 가능한 디스크 공간 요함.

02 장비

NVIDIA GeForce RTX 5070 그래픽 카드 상자에 들어 있는 내용물은 다음과 같습니다.

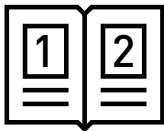

빠른 시작 가이드

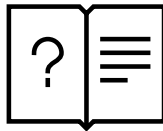

지원 가이드

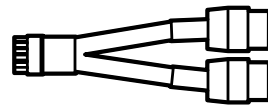

NVIDIA PCIe Gen5 16
핀 전원 커넥터 어댑터



주의: 동봉되어 있는 NVIDIA 파워 커넥터 어댑터를 GeForce RTX 50-시리즈 파운더스 에디션 그래픽 카드에 사용하기 바랍니다. 타사 파워 커넥터 어댑터를 사용하면 기술적인 문제가 발생할 수 있으며 제조업체 보증이 무효화 될 수 있습니다.

PCIe Gen5 16-pin
전원 커넥터



디스플레이포트
커넥터 (x3)

HDMI 커넥터

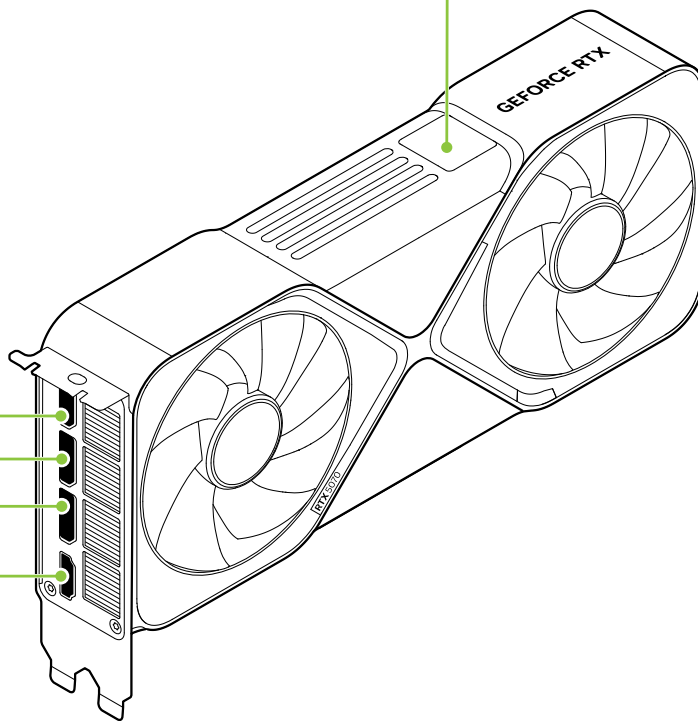

GeForce RTX 5070 Graphics Card

03 하드웨어 설치

- 1 컴퓨터를 끄고 전원 코드를 분리한 다음 기존 그래픽 카드를 꺼냅니다.



주의: 그래픽 카드가 식을 때까지 기다린 후 시스템에서 꺼내야합니다.

2 기존 그래픽 카드가 없는 경우 슬롯 커버 2 개를 제거합니다.

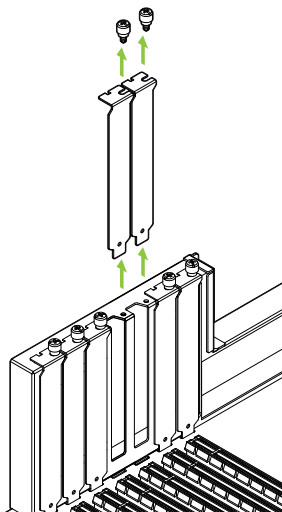

그래픽 카드를 설치할 PCI-Express 슬롯에
해당하는 인접한 슬롯 커버 2 개를 제거하세요.

- 3 NVIDIA 전원 커넥터 어댑터의 16핀 플러그를 GeForce RTX 5070 그래픽 카드 상단에 있는 전원 콘센트에 연결합니다.

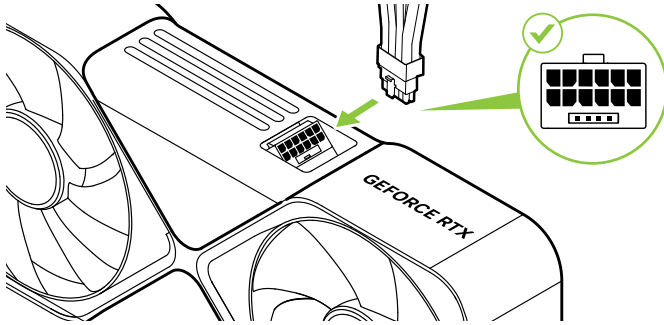

시스템 전원 공급 장치에서 NVIDIA 전원 커넥터 어댑터에 8 핀 PCIe Express 2 개 이상의 독립된 전용 케이블을 플러그로 연결.



주의: 동봉되어 있는 NVIDIA 파워 커넥터 어댑터를 GeForce RTX 50-시리즈 파운더스 에디션 그래픽 카드에 사용하기 바랍니다. 타사 파워 커넥터 어댑터를 사용하면 기술적인 문제가 발생할 수 있으며 제조업체 보증이 무효화 될 수 있습니다.

커넥터가 안전한지 확인하려면 그래픽 카드를 마더보드에 연결하기 전에 먼저 전원 동글을 그래픽 카드에 연결하여 견고하고 고르게 연결되었는지 확인하는 것이 좋습니다.



주의: 전원 플러그가 완전히 삽입되고 전원 콘센트와 같은 높이로 장착되었는지 확인하십시오.

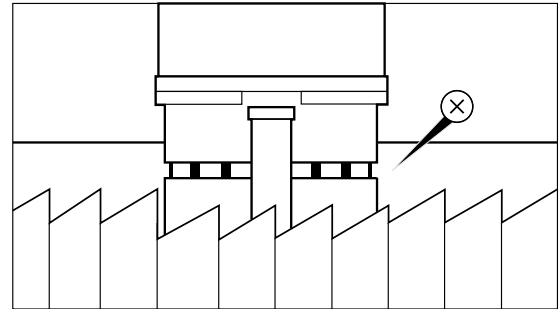
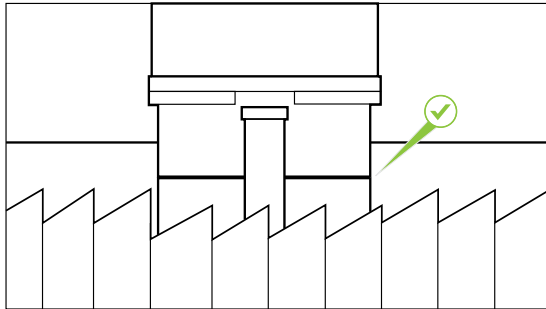

- 4 GeForce RTX 5070 그래픽 카드를 메인 보드의 기본 PCI Express x16 슬롯에 설치하십시오.

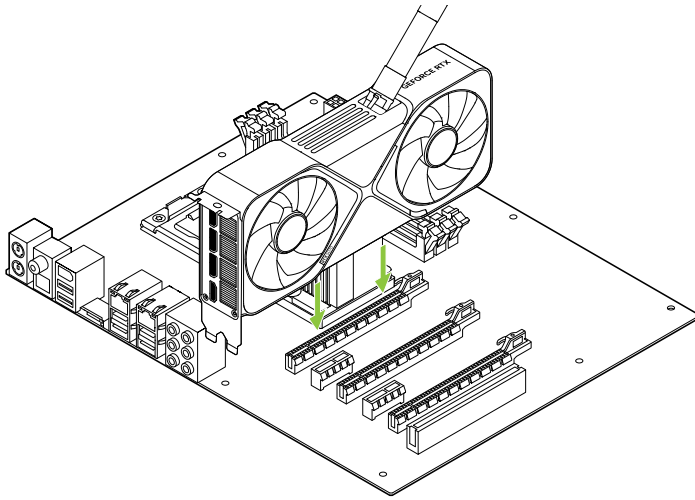

GeForce RTX 5070 을
기본 PCI Express x16
슬롯에 설치하십시오 (기본
슬롯은 CPU 에 가장 가까운
슬롯입니다).



주의: 이 GPU 카드는 I/O 브래킷이 아래쪽을 향하도록 설치해서는 안됩니다.

- 5 컴퓨터에서 커버를 다시 끼우고 분리한 케이블을 다시 연결합니다.

04 디스플레이에 연결

- 1 디스플레이를 그래픽 카드에 연결합니다.
- 2 전원 코드를 PC 에 다시 연결합니다.

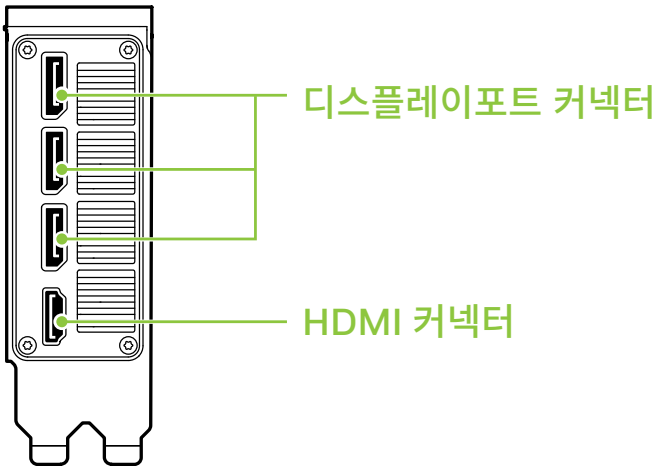

05 소프트웨어 설치 및 구성

하드웨어를 설치한 후에는 먼저 NVIDIA App 소프트웨어를 설치하여 드라이버를 업데이트하고 게임을 최적화해야 합니다.

1 NVIDIA App 소프트웨어를 다운로드하여 설치합니다.

- <https://www.nvidia.com/ko-kr/software/nvidia-app/> 로 이동하여 **Download Now** 를 클릭합니다.
- **Agree and Install** 을 선택하여 NVIDIA 소프트웨어 사용권 계약에 동의합니다. NVIDIA App 소프트웨어 설치가 시작됩니다.
- **Close** 를 선택하여 설치를 완료합니다.

2 축하합니다. 이제 GeForce 그래픽 카드를 사용할 준비가 되었습니다.



참고: NVIDIA 제품에 대해 궁금한 점이 있으면 www.nvidia.com/support에서 지원되는 NVIDIA 고객 지원 서비스를 받아보시기 바랍니다.

01 Compliances

The NVIDIA GeForce RTX 5070 graphics card (Compliance Model: PG146A) is compliant with the following regulations:

- Federal Communications Commission (FCC)
- Underwriters Laboratories (UL)
- Innovation, Science and Economic Development Canada (ISED)
- European Conformity; Conformité Européenne (CE)
- Australian Communications and Media Authority (RCM)
- UK Conformity Assessed (UKCA)
- Voluntary Control Council for Interference (VCCI)
- Korea Certification (KC)
- Bureau of Standards, Metrology & Inspection (BSMI)
- Ukraine Technical Regulations (UA TR)
- Moroccan regulatory framework (CMIM)

UNITED STATES

Federal Communications Commission (FCC)



This device complies with part 15 of the FCC Rules. Operation is subject to the following two conditions: (1) this device may not cause harmful interference, and (2) this device must accept any interference received, including any interference that may cause undesired operation of the device.

This equipment has been tested and found to comply with the limits for a Class B digital device, pursuant to Part 15 of the FCC Rules. These limits are designed to provide reasonable protection against harmful interference in a residential installation. This equipment generates uses and can radiate radio frequency energy and, if not installed and used in accordance with the instructions, may cause harmful interference to radio communications.

However, there is no guarantee that interference will not occur in a particular installation.

If this equipment does cause harmful interference to radio or television reception, which can be determined by turning the equipment off and on, the user is encouraged to try to correct the interference by one or more of the following measures:

- > Reorient or relocate the receiving antenna.
- > Increase the separation between the equipment and receiver.
- > Connect the equipment into an outlet on a circuit different from that to which the receiver is connected.
- > Consult the dealer or an experienced radio/TV technician for help.

FCC Warning: The FCC requires that you be notified that any changes or modifications to this device not expressly approved by the manufacturer could void the user's authority to operate the equipment.

Underwriters Laboratories (UL)



CANADA

Innovation, Science and Economic Development Canada (ISED)

CAN ICES-003(B)/NMB-003(B)

This device complies with Innovation, Science and Economic Development Canada (ISED) license-exempt RSS standard(s). Operation is subject to the following two conditions: (1) this device may not cause interference, and (2) this device must accept any interference, including interference that may cause undesired operation of the device.

Le présent appareil est conforme aux CNR d'Innovation, Sciences et Développement économique Canada applicables aux appareils radio exempts de licence. L'exploitation est autorisée aux deux conditions suivantes : (1) l'appareil ne doit pas produire de brouillage, et (2) l'utilisateur de l'appareil doit accepter tout brouillage radioélectrique subi, même si le brouillage est susceptible d'en compromettre le fonctionnement.

EUROPEAN UNION

European Conformity; Conformité Européenne (CE)



Santa Clara, California, USA

This device bears the CE mark accordance with Directive 2014/30/EU and 2011/65/EU.

This device complies with the following Directives:

- > EMC Directive 2014/30/EU
- > RoHS Directive 2011/65/EU for hazardous substances

A copy of the Declaration of Conformity to the essential requirements may be obtained directly from NVIDIA GmbH (Bavaria Towers – Blue Tower, Einsteinstrasse 172, D-81677 Munich Germany).

AUSTRALIA AND NEW ZEALAND

Australian Communications and Media Authority (RCM)



This product meets the applicable EMC requirements for Class B, I.T.E equipment and applicable radio equipment requirements

GREAT BRITAIN (ENGLAND, WALES AND SCOTLAND)

UK Conformity Assessed (UKCA)



This device complies with the following Regulations:

- > SI 2016/1091: Electromagnetic Compatibility (EMC)
- > SI 2012/3032: The Restriction of the Use of Certain Hazardous Substances in Electrical and Electronic Equipment (As Amended)

A copy of the Declaration of Conformity to the essential requirements may be obtained directly from NVIDIA Ltd. (100 Brook Drive, 3rd Floor Green Park, Reading RG2 6UJ, United Kingdom).

JAPAN

Voluntary Control Council for Interference (VCCI)



この装置は、クラスB機器です。この装置は、住宅環境で使用することを目的としていますが、この装置がラジオやテレビジョン受信機に近接して使用されると、受信障害を引き起こすことがあります。

取扱説明書に従って正しい取り扱いをして下さい。

VCCI - B

Japan RoHS Material Content Declaration

日本工業規格 JIS C 0950:2008 により、2006 年7月1日以降に販売される特定分野の電気および電子機器について、製造者による含有物質の表示が義務付けられます。

機器名称: グラフィックカード

主な分類	特定化学物質記号					
	Pb	Hg	Cd	Cr(VI)	PBB	PBDE
PCB ボード	0	0	0	0	0	0
パッシブ電子部品	除外項目	0	0	0	0	0
アクティブ電子部品	除外項目	0	0	0	0	0
プロセッサ	0	0	0	0	0	0
メモリ	0	0	0	0	0	0
機械部品	除外項目	0	0	0	0	0
ケーブル/コネクタ	0	0	0	0	0	0

はんだ付け材料	0	0	0	0	0	0
フラックス、クリームはんだ、ラベル、その他消耗品	0	0	0	0	0	0

注：

- 「0」は、特定化学物質の含有率が日本工業規格 JIS C 0950:2008 に記載されている含有率基準値より低いことを示します。
- 「除外項目」は、特定化学物質が含有マークの除外項目に該当するため、特定化学物質について、日本工業規格 JIS C 0950:2008 に基づく含有マークの表示が不要であることを示します。
- 「0.1wt% 超」または「0.01wt% 超」は、特定化学物質の含有率が日本工業規格 JIS C 0950:2008 に記載されている含有率基準値を超えていることを示します。

A Japanese regulatory requirement, defined by specification JIS C 0950: 2008, mandates that manufacturers provide Material Content Declarations for certain categories of electronic products offered for sale after July 1, 2006.

Product Model Number: Graphic card

Major Classification	Symbols of Specified Chemical Substance					
	Pb	Hg	Cd	Cr(VI)	PBB	PBDE
PCB	0	0	0	0	0	0
Passive components	Exempt	0	0	0	0	0

Active components	Exempt	0	0	0	0	0
Processor	0	0	0	0	0	0
Memory	0	0	0	0	0	0
Mechanicals	Exempt	0	0	0	0	0
Cables/Connectors	0	0	0	0	0	0
Soldering material	0	0	0	0	0	0
Flux, Solder Paste, label and other consumable materials	0	0	0	0	0	0

Notes:

1. "0" indicates that the level of the specified chemical substance is less than the threshold level specified in the standard, JIS C 0950: 2008.
2. "Exempt" indicates that the specified chemical substance is exempt from marking and it is not required to display the marking for that specified chemical substance per the standard, JIS C 0950: 2008.
3. "Exceeding 0.1wt%" or "Exceeding 0.01wt%" is entered in the table if the level of the specified chemical substance exceeds the threshold level specified in the standard, JIS C 0950: 2008.

KOREA

Korea Certification (KC)



R-R-NVA-PG146A

B급 기기	이 기기는 가정용(B급) 전자파적합기기로서 주
	로 가정에서 사용하는 것을 목적으로 하며, 모
	든 지역에서 사용할 수 있습니다.

Korea RoHS Material Content Declaration

확인 및 평가 양식은 제품에 포함 된 유해 물질의 허용 기준의 준수에 관한				
문 준비	상xxXXXXx호 :	앤비디아홍콩홀딩즈리미티드 (영업소)	법인등록번호	110181-0036373
	대표자성명	카렌테레사번즈	사업자등록번호:	120-84-06711
	주소	서울특별시 강남구 영동대로 511, 2101 호 (삼성동, 코엑스무역타워)		
제품 내용				
제품의 종류	개인용 컴퓨터	제품명(규격)	그래픽카드	
세부모델명(번호):	해당없음	제품출시일	해당없음	
제품의 중량	해당없음	제조, 수입업자	앤비디아	

엔비디아의 그래픽 카드제품은 전기 전자제품 및 자동차의 자원순환에 관한 법률 시행령 제 11조 제 1항에 의거한 법 시행행규칙 제 3조에따른 유해물질함유 기준을 확인 및 평가한 결과, 이를 준수하였음을 공표합니다.

구비서류 : 없음

작성방법

- ① 제품의 종류는 “전기.전자제품 및 자동차의 자원순환에관한 법률 시행령” 제 8조 제 1항 및 제 2 항에 따른 품목별로 구분하여 기재합니다.
- ② 전기 전자 제품의 경우 모델명 (번호), 자동차의 경우, 제원관리번호를 기재합니다.
- ③ 해당제품의 제조업자 또는 수입업자를 기재합니다.

Confirmation and Evaluation Form Concerning the Adherence to Acceptable Standards of Hazardous Materials Contained in Products

Statement Prepared by	Company Name:	Nvidia HongKong Holding Ltd. Korea branch	Corporate Identification Number:	110181-0036373
	Name of Company Representative:	Karen Theresa Burns	Business Registration Number:	120-84-06711
	Address	2788 San Tomas Expressway, Santa Clara, CA 95051		

Product Information

Product Category:	PC	Name of Product:	Graphic Card
Detailed Product Model Name (Number):	N/A	Date of first market release:	N/A
Weight of Product:	N/A	Manufacturer and/or Importer:	NVIDIA Corporation

NVIDIA has evaluated and confirmed that the products comply with the standards for the content of hazardous substances in accordance with Article 3 of the 'Act on Resource Circulation of Electrical and Electronic Equipment and Vehicles' pursuant to the Enforcement Regulations of Article 11, Paragraph 1 in the statute.

Attachment: None

*Preparing the Form

- ① Please indicate the product category according to the categories listed in Article 8, Items 1 and 2 of the 'Enforcement Ordinance of the Statute on the Recycling of Electrical, Electronic and Automobile Materials'
- ② For electrical and electronic products, please indicate the Model Name (and number). For automobiles, please indicate the Vehicle Identification Number.
- ③ Please indicate the name of manufacturer and/or importer of the product.

TAIWAN

Bureau of Standards, Metrology & Inspection (BSMI)

D33088
RoHS

Taiwan RoHS Material Content Declaration

<p>限用物質含有情況標示聲明書 Declaration of the presence condition of the Restricted Substances Marking</p>						
<p>設備名稱：繪圖卡 Equipment Name: Graphic Card</p>						
<p>單元 Parts</p>	<p>限用物質及其化學符號 Restricted substances and its chemical symbols</p>					
	<p>鉛 (Pb)</p>	<p>汞 (Hg)</p>	<p>鎘 (Cd)</p>	<p>六價鉻 (Cr(VI))</p>	<p>多溴聯 苯 (PBB)</p>	<p>多溴二 苯醚 (PBDE)</p>

PCB板 PCB	0	0	0	0	0	0
被動電子零件 Passive components	-	0	0	0	0	0
主動電子零件 Active components	-	0	0	0	0	0
處理器 Processor	0	0	0	0	0	0
內存 Memory	0	0	0	0	0	0
結構件以及風扇 Mechanical parts and Fan	-	0	0	0	0	0
線材/連接器 Cables/Connectors	0	0	0	0	0	0
焊接金屬 Soldering material	0	0	0	0	0	0
助焊劑, 錫膏, 標籤及耗材 Flux, Solder Paste, label and other consumable materials	0	0	0	0	0	0

備考1: O: 系指該限用物質未超出百分比含量基準值

Note 1: O: indicates that the percentage content of the restricted substance does not exceed the percentage of reference value of presence.

備考2: O: 系指該項限用物質為排外項目。

Note 2: O: indicates that the restricted substance corresponds to the exemption.

此表中所有名稱中含“-”的部件均符合歐盟 RoHS 立法。

All parts named in this table with an “-” are in compliance with the European Union’s RoHS Legislation.

注: 環保使用期限的參考標識取決與產品正常工作的溫度和濕度等條件

Note: The referenced Environmental Protection Use Period Marking was determined according to normal operating use conditions of the product such as temperature and humidity.

CHINA

China RoHS Material Content Declaration



产品中有害物质的名称及含量

The Table of Hazardous Substances and their Content

根据中国《电器电子产品有害物质限制使用管理办法》

as required by Management Methods for Restricted Use of Hazardous Substances in Electrical and Electronic Products

部件名称 Parts	有害物质 Hazardous Substances					
	铅 (Pb)	汞 (Hg)	镉 (Cd)	六价铬 (Cr(VI))	多溴联苯 (PBB)	多溴二苯醚 (PBDE)
PCB板 PCB	0	0	0	0	0	0
被动电子零件 Passive components	X	0	0	0	0	0
主动电子零件 Active components	X	0	0	0	0	0
处理器 Processor	0	0	0	0	0	0
内存 Memory	0	0	0	0	0	0

结构件以及风扇 Mechanical parts and Fan	X	0	0	0	0	0
线材/连接器 Cable/Connectors	0	0	0	0	0	0
焊接金属 Soldering material	0	0	0	0	0	0
助焊剂, 锡膏, 标签及耗材 Flux, Solder Paste, label and other consumable materials	0	0	0	0	0	0

本表格依据SJ/T 11364-2014 的规定编制

The table according to SJ/T 11364

O: 表示该有害物质在该部件所有均质材料中的含量均在GB/T 26572 标准规定的限量要求以下。

O: Indicates that this hazardous substance contained in all of the homogeneous materials for this part is below the limit requirement in GB/T 26572.

X: 表示该有害物质至少在该部件的某一均质材料中的含量超出GB/T 26572 标准规定的限量要求。

X: Indicates that this hazardous substance contained in at least one of the homogeneous materials used for this part is above the limit requirement in GB/T 26572.

此表中所有名称中含“X”的部件均符合欧盟 RoHS 立法。

All parts named in this table with an “X” are in compliance with the European Union’s RoHS Legislation.

注: 环保使用期限的参考标识取决于产品正常工作的温度和湿度等条件

Note: The referenced Environmental Protection Use Period Marking was determined according to normal operating use conditions of the product such as temperature and humidity.

INDIA

India RoHS Material Content Declaration

This product, as well as its related consumables and spares, complies with the reduction in hazardous substances provisions of the “India E-waste (Management and Handling) Rule 2016”. It does not contain lead, mercury, hexavalent chromium, polybrominated biphenyls or polybrominated diphenyl ethers in concentrations exceeding 0.1 weight % and 0.01 weight % for cadmium, except for where allowed pursuant to the exemptions set in Schedule 2 of the Rule.

India RoHS Self-Declaration Form (as per E-Waste (Management) Rules, 2016)								
Sr. No.	Product Category & Code (as Per Schedule I of E-Waste (M) Rules, 2016)	Product name	Model No.	Product Weight (g)	Date of placing on market	Compliance with RoHS Yes/No	RoHS Information provided on product info booklet Yes/No	In case Product is imported from other country, name of the country manufactured
i.	TEW2 (Graphic Card)	Graphic Card	N/A	N/A	N/A	Yes	Yes	China

UKRAINE

Ukraine Technical Regulations (UA TR)



Цей пристрій відповідає наступним технічним регламентам:

- > Технічного регламенту з електромагнітної сумісності обладнання
- > Технічного регламенту обмеження використання деяких небезпечних речовин в електричному та електронному обладнанні

MOROCCO

Moroccan regulatory framework (CMIM)



Notice

The information provided in this specification is believed to be accurate and reliable as of the date provided. However, NVIDIA Corporation ["NVIDIA"] does not give any representations or warranties, expressed or implied, as to the accuracy or completeness of such information. NVIDIA shall have no liability for the consequences or use of such information or for any infringement of patents or other rights of third parties that may result from its use. This publication supersedes and replaces all other specifications for the product that may have been previously supplied.

NVIDIA reserves the right to make corrections, modifications, enhancements, improvements, and other changes to this specification, at any time and/or to discontinue any product or service without notice. Customer should obtain the latest relevant specification before placing orders and should verify that such information is current and complete.

NVIDIA products are sold subject to the NVIDIA standard terms and conditions of sale supplied at the time of order acknowledgement, unless otherwise agreed in an individual sales agreement signed by authorized representatives of NVIDIA and customer. NVIDIA hereby expressly objects to applying any customer general terms and conditions with regard to the purchase of the NVIDIA product referenced in this specification.

NVIDIA products are not designed, authorized or warranted to be suitable for use in medical, military, aircraft, space or life support equipment, nor in applications where failure or malfunction of the NVIDIA product can reasonably be expected to result in personal injury, death or property or environmental damage. NVIDIA accepts no liability for inclusion and/or use of NVIDIA products in such equipment or applications and therefore such inclusion and/or use is at customer's own risk.

NVIDIA makes no representation or warranty that products based on these specifications will be suitable for any specified use without further testing or modification. Testing of all parameters of each product is not necessarily performed by NVIDIA. It is customer's sole responsibility to ensure the product is suitable and fit for the application planned by customer and to do the necessary testing for the application in order to avoid a default of the application or the product. Weaknesses in customer's product designs may affect the quality and reliability of the NVIDIA product and may result in additional or different conditions and/or requirements beyond those contained in this specification. NVIDIA does not accept any liability related to any default, damage, costs or problem which may be based on or attributable to: (i) the use of the NVIDIA product in any manner that is contrary to this specification, or (ii) customer product designs.

No license, either expressed or implied, is granted under any NVIDIA patent right, copyright, or other NVIDIA intellectual property right under this specification. Information published by NVIDIA regarding third-party products or services does not constitute a license from NVIDIA to use such products or services or a warranty or endorsement thereof. Use of such information may require a license from a third party under the patents or other intellectual property rights of the third party.

ALL NVIDIA DESIGN SPECIFICATIONS, REFERENCE BOARDS, FILES, DRAWINGS, DIAGNOSTICS, LISTS, AND OTHER DOCUMENTS [TOGETHER AND SEPARATELY, "MATERIALS"] ARE BEING PROVIDED "AS IS." NVIDIA MAKES NO WARRANTIES, EXPRESSED, IMPLIED, STATUTORY, OR OTHERWISE WITH RESPECT TO THE MATERIALS, AND EXPRESSLY DISCLAIMS ALL IMPLIED WARRANTIES OF

NONINFRINGEMENT, MERCHANTABILITY, AND FITNESS FOR A PARTICULAR PURPOSE. Notwithstanding any damages that customer might incur for any reason whatsoever, NVIDIA's aggregate and cumulative liability towards customer for the products described herein shall be limited in accordance with the NVIDIA terms and conditions of sale for the product.

VESA DisplayPort

DisplayPort and DisplayPort Compliance Logo, DisplayPort Compliance Logo for Dual-mode Sources, and DisplayPort Compliance Logo for Active Cables are trademarks owned by the Video Electronics Standards Association in the United States and other countries.



HDMI, the HDMI logo, and High-Definition Multimedia Interface are trademarks or registered trademarks of HDMI Licensing LLC.

OpenCL

OpenCL is a trademark of Apple Inc. used under license to the Khronos Group Inc.

MPEG LA (H.264/AVC)

THIS PRODUCT IS LICENSED UNDER THE AVC PATENT PORTFOLIO LICENSE FOR THE PERSONAL USE OF A CONSUMER OR OTHER USES IN WHICH IT DOES NOT RECEIVE REMUNERATION TO [(i) ENCODE VIDEO IN COMPLIANCE WITH THE AVC STANDARD [""AVC VIDEO""] AND/OR [(ii) DECODE AVC VIDEO THAT WAS ENCODED BY A CONSUMER ENGAGED IN A PERSONAL ACTIVITY AND/OR WAS OBTAINED FROM A VIDEO PROVIDER LICENSED TO PROVIDE AVC VIDEO. NO LICENSE IS GRANTED OR SHALL BE IMPLIED FOR ANY OTHER USE. ADDITIONAL INFORMATION MAY BE OBTAINED FROM MPEG LA, L.L.C. SEE [HTTP://WWW.MPEGLA.COM](http://www.mpegla.com).

Access Advance

This product is covered by one or more claims of the HEVC patents listed at patentlist.accessadvance.com

Trademarks

NVIDIA, the NVIDIA logo, NVIDIA CUDA, NVIDIA GeForce, GeForce RTX, Ge Force Experience, NVIDIA NVLink, GigaThread, Lumenex, PureVideo, and PhysX Technology are trademarks or registered trademarks of NVIDIA Corporation. Other company product names may be trademarks of the respective companies with which they are associated.

Copyright

© 2025 NVIDIA Corporation. All rights reserved.

www.nvidia.com

© 2025 NVIDIA Corporation. All rights reserved.

